

STIGA

A 300
A 500
A 750
A 1000
A 1500

A 3000
A 5000
A 7500
A 10000

EN

INSTRUCTION MANUAL



TABLE OF CONTENTS

1. MODELS AND TECHNICAL DATA	1
1.1. MODELS.....	1
1.2. TECHNICAL DATA	2
2. SAFETY	5
2.1. SAFETY INFORMATION	5
2.2. SAFETY INSTRUCTIONS	7
2.2.1. SAFE OPERATING PROCEDURES.....	7
2.2.2. OPERATION	7
2.3. STOPPING AND TURNING OFF THE ROBOT LAWN MOWER IN SAFE CONDITIONS.....	9
2.4. MOVING THE MACHINE	9
3. INTRODUCTION	10
3.1. GENERAL INTRODUCTION	10
3.1.1. PURPOSE OF THE MANUAL.....	10
3.1.2. INSTRUCTIONS FOR READING FROM SMARTPHONE	10
3.2. PRODUCT OVERVIEW.....	11
3.2.1. GENERAL DESCRIPTION	11
3.2.2. MAIN COMPONENTS	12
3.3. UNPACKING.....	13
3.4. SYMBOLS AND NAMEPLATES.....	14
3.5. GENERAL MANUAL READING INSTRUCTIONS.....	16
4. INSTALLATION	17
4.1. GENERAL INSTALLATION INFORMATION	17
4.2. INSTALLATION COMPONENTS.....	17
4.3. VERIFICATION OF THE INSTALLATION REQUIREMENTS.....	18
4.3.1. GARDEN VERIFICATION:.....	18
4.3.2. CHECKS FOR THE INSTALLATION OF THE CHARGING BASE AND POWER SUPPLY:.....	18
4.3.3. CHECKS TO DEFINE THE VIRTUAL PERIMETERS:.....	24
4.4. CRITERIA FOR DELIMITING WORK AREAS AND TRANSITION ROUTES.....	26
4.4.1. MINIMUM VIRTUAL BOUNDARIES AND DELIMITATION DISTANCES.....	26
4.4.2. NARROW PASSAGES.....	28
4.4.3. CLOSED AREAS	28
4.4.4. TRANSITION ROUTES	29
4.5. COMPONENTS INSTALLATION.....	30
4.5.1. INSTALLATION OF THE CHARGING BASE.....	31
4.5.2. INSTALLING THE SATELLITE REFERENCE STATION	33
4.5.3. RECHARGE THE ROBOT LAWN MOWER AFTER INSTALLATION	37
4.6. PROGRAMMING VIRTUAL PERIMETERS, TRANSITION ROUTES AND AREAS TO BE AVOIDED.....	37
4.7. PRODUCT FEATURES AND SETTINGS	39
4.7.1. PRELOGIN.....	39
4.7.2. SIGN UP.....	39
4.7.3. DEVICE PAIRING	39
4.7.4. REMOTE CONNECTIVITY AND SIM CARD ACTIVATION	40
4.7.5. GARAGE AND DEVICE PAGE	40

4.7.6.	CONFIGURATION OF THE CHARGING BASE	41
4.7.7.	CALIBRATION OF THE CHARGING BASE	41
4.7.8.	INITIALIZATION OF THE ROBOT LAWN MOWER	41
4.7.9.	PROGRAMMING VIRTUAL PERIMETERS, TRANSITION ROUTES AND AREAS TO BE AVOIDED.....	42
4.7.10.	PROGRAMMING THE RETURN ROUTE TO THE CHARGING BASE	43
4.7.11.	GARDEN MAP	44
4.7.12.	SPOT CUT / SCHEDULED	44
4.7.13.	SCHEDULING MOWING SESSIONS	44
4.7.14.	DATA PACKAGE MANAGEMENT	45
4.7.15.	INTEGRATION WITH VOICE ASSISTANTS (DEPENDING ON THE MODEL) (AMAZON ALEXA, GOOGLE HOME)	45
4.7.16.	APP LOCK	45
4.7.17.	SETTING THE DESIRED NAVIGATION MODE	45
4.7.18.	BORDER CUT.....	46
4.7.19.	RAIN SENSOR.....	46
4.7.20.	FIRMWARE UPDATE.....	46
4.7.21.	PROFILE / USER MANAGEMENT / CHOICE OF PREFERRED DEALER / MESSAGING	46
4.7.22.	ANTI-THEFT DEVICE (DEPENDING ON THE MODEL).....	46
4.7.23.	CHANGING OR DELETING VIRTUAL PERIMETERS, TRANSITION ROUTES AND AREAS TO BE AVOIDED....	47
4.7.24.	SETTING GARDEN AREA MOWING PRIORITIES	47
4.7.25.	TEMPORARY NO-CUT ZONE (DEPENDING ON MODEL).....	47
4.7.26.	STAY AWAY (DEPENDING ON THE MODEL)	48
4.7.27.	OBSTACLE NOTIFICATION (DEPENDING ON THE MODEL).....	48
4.7.28.	CUTTING MODE FOR LARGE OPEN AREAS (WIDE AREA MODE) (DEPENDING ON THE MODEL).....	49

5. OPERATION 49

5.1.	CHECK OF SAFETY DEVICES FOR STARTING THE ROBOT LAWN MOWER	49
5.2.	MANUAL FUNCTIONING OF THE ROBOT LAWN MOWER.....	50
5.3.	DESCRIPTION OF THE CONTROLS ON THE ROBOT LAWN MOWER.....	51
5.3.1.	SAFE STOP - STOP BUTTON	52
5.3.2.	SAFE SHUTDOWN - SAFETY KEY	52
5.3.3.	SWITCHING THE ROBT LAWN MOWER ON AND OFF - ON / OFF BUTTON.....	53
5.3.4.	SCHEDULED PROGRAMME SELECTION / SINGLE WORK CYCLE / FORCED RETURN TO CHARGING BASE - MODE SELECTION BUTTON	54
5.3.5.	BLUETOOTH® STATUS DISPLAY - BLUETOOTH® BUTTON.....	56
5.3.6.	DISPLAY OF ALARM STATES-ALARM ICON	56
5.3.7.	BATTERY CHARGE DISPLAY-BATTERY ICON.....	57
5.3.8.	STARTING THE ROBOT LAWN MOWER	58
5.4.	FUNCTIONING OF THE CHARGING BASE.....	58
5.5.	BATTERY CHARGING	58
5.6.	CUTTING HEIGHT ADJUSTMENT	59
5.6.1.	AUTOMATIC CUTTING HEIGHT ADJUSTMENT (IF AVAILABLE).....	59

6. MAINTENANCE 60

6.1.	SCHEDULED MAINTENANCE	60
6.2.	PRODUCT CLEANING.....	61
6.3.	REPLACEMENT OF THE CUTTING BLADES	63
6.4.	WINTER BATTERY MAINTENANCE AND STORAGE	64
6.5.	BATTERY REPLACEMENT	64

7. TROUBLESHOOTING	65
8. TRANSPORT, STORAGE AND DISPOSAL	67
8.1. TRANSPORT	67
8.2. STORAGE.....	67
8.3. DISPOSAL.....	67
9. ACCESSORIES	68
10. WARRANTY	69
10.1. WARRANTY COVERAGE.....	69
11. REGISTERED TRADEMARKS AND LICENCES	69
12. EC DECLARATION OF CONFORMITY	70
13. POWER SUPPLIER	72

1. MODELS AND TECHNICAL DATA

1.1. MODELS

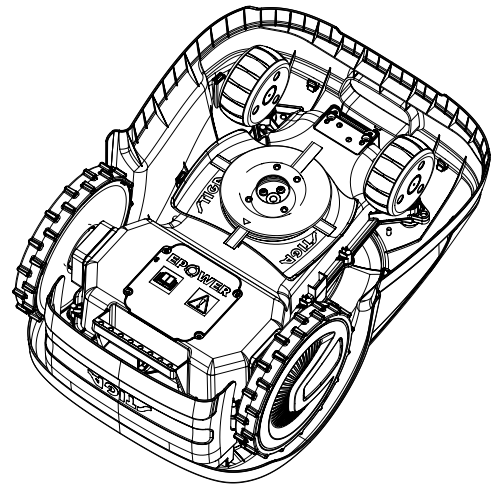
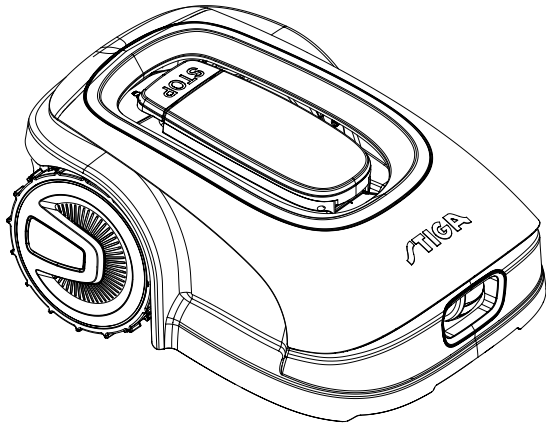

A300, A500, A750, A1000, A1500
(TYPE SRSA01)

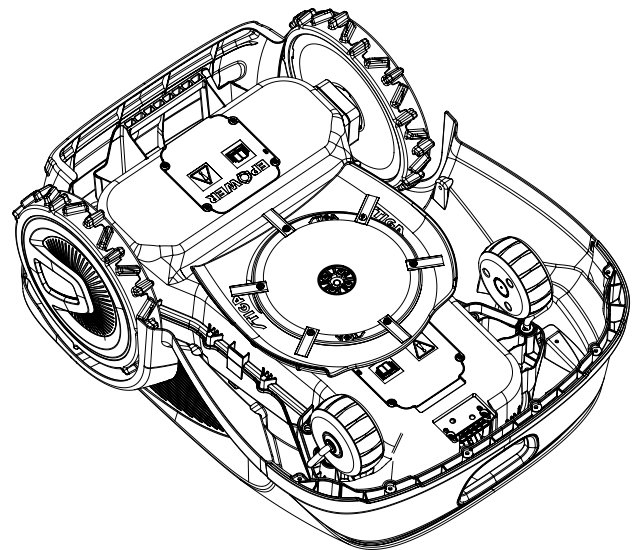
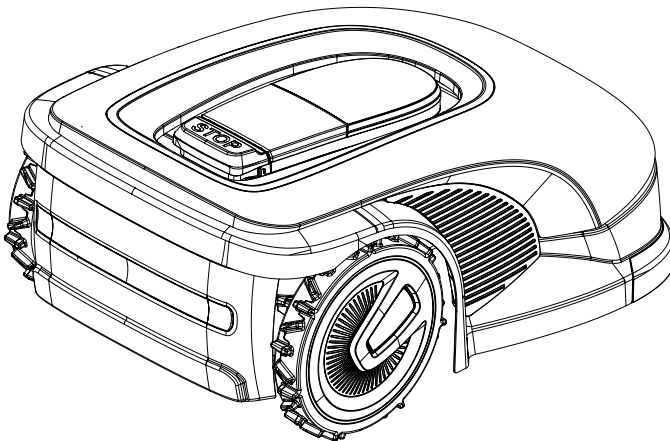

A3000, A5000, A7500, A10000
(TYPE SRBA01)

NOTE: the instructions in this manual apply to independent robot lawn mower models. All illustrations, unless otherwise indicated, refer to the SRSA01 platform.

1.2. TECHNICAL DATA

SPECIFICATIONS	STIGA A 300	STIGA A 500	STIGA A 750	STIGA A 1000	STIGA A 1500	STIGA A 3000	STIGA A 5000	STIGA A 7500	STIGA A 10000
Dimensions (WxHxD)	413 x 252 x 560 [mm]					529 x 299 x 695 [mm]			
Weight of the robot lawn mower	8.1+/- 0.1 [kg]				8.4+/- 0.1 [kg]	12.7+/- 0.1 [kg]	13.4+/- 0.1 [kg]	13.5+/- 0.1 [kg]	
Cutting height (Min-Max)	20-60 [mm]					20-65 [mm]			
Blade diameter	180 [mm]					260 [mm]			
Cutting speed	2850+/-50 [rpm]					2400+/-50 [rpm]			
Speed of movement	22 [m/min]					24 [m/min]		26 [m/min]	
Maximum slope	45%					50%			
Maximum slope along the perimeter	20%								
Type of cutting system	4 pivoting cutting blades					6 pivoting cutting blades			
Cutting device code	322104105/0								
Sound power level detected	57 [dB] (A)					56 [dB] (A)		60 [dB] (A)	
Uncertainty of noise emissions, KWA	1.47 [dB] (A)					0.56 [dB] (A)		0.65 [dB] (A)	
Sound power level guaranteed	59 [dB] (A)					57 [dB] (A)		60 [dB] (A)	
Acoustic pressure level at the operator's ear	46.3 [dB] (A)					45.2 [dB] (A)		48.6 [dB] (A)	
IP rating of the robot lawn mower	IPX5								
IP rating of the charging station	IPX1								
IP rating of the power supply	IP67								
Robot lawn mower operating ambient temperature [°C]	0 ÷ 50								

Charging station operating ambient temperature [°C]	-10 ÷ 50								
Power supply operating ambient temperature [°C]	-10 ÷ 50								
Optimal and recommended work capacity (2 work cycles per day - 3 work cycles per day for A7500 and A10000)	300 [m ²]	500 [m ²]	750 [m ²]	1000 [m ²]	1500 [m ²]	3000 [m ²]	5000 [m ²]	7500 [m ²]	10000 [m ²]
Maximum operating capacity	450 [m ²]	700 [m ²]	900 [m ²]	1400 [m ²]	2500 [m ²]	4500 [m ²]	7000 [m ²]	9000 [m ²]	12000 [m ²]
Maximum area manageable from each Closed Area	70 [m ²]		100 [m ²]	150 [m ²]	250 [m ²]	450 [m ²]	800 [m ²]	800 [m ²]	1200 [m ²]
Power supply	Input: 100-240 Vac, 1.2 A; Output: 30 VDC, 2 A Use one of the original codes below or subsequent updates (consult an authorised STIGA dealer) 118204158/0 (UE) 118204161/0 (UK) 118204163/0 (CH)						Input: 200-240 Vac, 0.8 A; Output: 30 VDC, 4 A Use one of the original codes below or subsequent updates (consult an authorised STIGA dealer) 118204159/0 (UE) 118204162/0 (UK) 118204164/0 (CH)		
30 VDC extension cables permitted	Use one of the original codes below or subsequent updates (consult an authorised STIGA dealer) Code: 1127-0010-01, Length 5 m Code: 1127-0020-01, Length 15 m								
Battery model	25,2V - 2Ah		25.2 V-2.5 Ah		25.2 V-5Ah		25.2V – 2x 5Ah		25.2V – 2x 6Ah
Charging time	40 [min]		60 [min]	80 [min]	150 [min]			180 [min]	
Operating time	40 [min]		60 [min]	90 [min]	150 [min]		270 [min]		330 [min]
Connectivity:	Bluetooth®, 4G, GNSS-RTK								
Power class RF Modules	Bluetooth LE Output power - 9 dBm 2G GSM / E-GSM - Class 4 - 33 dBm 2G DCS / PCS - Class 1 - 30 dBm 2G GSM / E-GSM - Class E2 - 27 dBm 2G DCS / PCS - Class E2 - 26 dBm 4G - Class 3 - 23dBm								

Frequency range - Bluetooth®	Bluetooth LE - Frequency range 2400 - 2483.5 MHz
Frequency range - 2G	GSM 850 MHz E-GSM 900 MHz DCS 1800 MHz PCS 1900 MHz
Frequency range - 4G	Band 1 (2100 MHz) Band 2 (1900 MHz) Band 3 (1800 MHz) Band 4 (2100 MHz) Band 5 (850 MHz) Band 7 (2600 MHz) Band 8 (900 MHz) Band 12 (700 MHz) Band 13 (750 MHz) Band 17 (700 MHz) Band 18 (850 MHz) Band 19 (850 MHz) Band 20 (800 MHz) Band 26 (850 MHz) Band 28 (800 MHz) Band 34 (2000 MHz) Band 38 (2500 MHz) Band 39 (1900 MHz) Band 40 (2300 MHz) Band 41 (2500 MHz) Band 66 (2100 MHz)
Perimeter cable the charging base antenna	Operating frequency band 500 - 50000 (Hz)
	Maximum radio emission power < 70 μ A/m @ 10m

2. SAFETY

2.1. SAFETY INFORMATION

In the design of the device, special attention has been paid to aspects that can cause risks to the safety and health of people. The purpose of this information is to sensitize users to prevent any risk, avoiding behaviours that do not comply with the regulations reported.



DANGER:

Before using the robot lawn mower you must know all the information contained in this document.



DANGER:

This robot lawn mower is not intended to be used by children and people with reduced physical, sensory or mental abilities or with lack of experience and knowledge.



ELECTRICAL HAZARD:

Before carrying out any adjustment or maintenance intervention, disconnect the power supply and activate the safety device.



ELECTRICAL HAZARD:

Do not use the robot lawn mower with a damaged transformer power cable. A damaged cable can lead to contact with live parts. The cable must be replaced by the manufacturer or its assistance service or by a person with adequate qualifications, in order to prevent any risk.



ELECTRICAL HAZARD:

Only use the battery charger and power supply provided by the manufacturer. The use of an inappropriate charger and power supply can cause electric shocks and / or overheating.



CAUTION:

In case of leakage of liquid from the battery, the affected components must be washed with water / neutralizer.

Avoid any direct contact with the battery liquid.

If the liquid comes into contact with the eyes, call a doctor immediately.



CAUTION:

During the operation of the robot lawn mower, make sure that there are no people, especially children, or land pets, in the operating area . Otherwise, program the activity of the robot lawn mower during the hours when there are no people in that area.



CAUTION:

The operating area and more generally the area in which the robot lawn mower can travel must be cordoned off by fencing.



CAUTION:

The operating area or routes used by the machine while operating must be set up away from public areas to avoid damage to persons, property or vehicle accidents.



CAUTION:

For safety reasons, the satellite reference station must never be moved after the programming of the virtual perimeters, transition routes and areas to be avoided. The robot lawn mower could exit the programmed work area. If the reference station is moved, the programming must be repeated.



CAUTION:

Do not touch the cutting means when adjusting the cutting height.



CAUTION:

For your own safety and in order to avoid damage to persons, animals or property, the operator must have prior knowledge of the area where the robot lawn mower will be manually guided (e.g. during installation). When guiding the robot, walk carefully to avoid tripping.



CAUTION:

Only use original spare parts.



CAUTION:

Do not modify, tamper with, elude or eliminate the safety devices installed.



WARNING:

Check that there are no toys, tools, branches, clothing, or other items on the lawn that could damage the device.



BAN:

Do not sit on top of the robot lawn mower.



BAN:

Never lift the robot lawn mower to inspect the blade or to transport it when it's started. Do not put your hands and feet under the device.



BAN:

Do not use the robot lawn mower when a sprinkler is in operation.



BAN:

Do not wash the robot lawn mower with high pressure water jets, and do not immerse it, partially or completely, in water.



BAN:

Do not use the robot lawn mower if it is not perfectly intact in all its parts. In case of damage replace the affected parts.



BAN:

It is absolutely forbidden to use and recharge the robot lawn mower in explosive and inflammable environments.



OBLIGATION:

Visually check the robot lawn mower at regular intervals to make sure the blades and mowing mechanism are not worn out or damaged. Make sure that the robot lawn mower is in good operating conditions.



OBLIGATION:

Read the entire manual carefully, especially all safety information, and make sure you fully understand it. Follow the operating, maintenance and repair instructions carefully.



OBLIGATION:

Operators carrying out maintenance and repair interventions must be fully familiar with its specific characteristics and safety standards.



GLOVES OBLIGATION:

Use personal protection foreseen by the Manufacturer. Always use protective gloves when working on the cutting mechanism.

2.2. SAFETY INSTRUCTIONS



OBLIGATION:

Read carefully before use and store for future reference.

2.2.1. SAFE OPERATING PROCEDURES

Training

- a. Read the instructions carefully, learn the controls and the correct use of the machine.
- b. Never allow children, persons with reduced physical, sensory or mental capabilities, or lack of experience and knowledge, or persons unfamiliar with these instructions, to operate the machine. Local regulations may limit the age of the operator.
- c. The operator, or user, is to be held responsible for accidents or hazards involving third parties or third party equipment.

Preparation

- a. Check whether the automatic perimeter delimitation system is programmed correctly as specified in the instructions.
- b. Periodically check the area where the machine is used and remove stones, sticks, cables and any other foreign objects that may interfere with its operation.
- c. Periodically carry out a visual inspection of the blades, blade bolts and of the cutting unit to check that they are not worn out or damaged. Replace worn out or damaged blades and bolts in pairs to maintain the balance of the machine.
- d. Warning signs must be placed around the working area of the machine if it is used in public areas or areas open to the public. Signs must read as follows: "Warning! Automatic lawn mower! Keep away from the machine! Children must be supervised!"

2.2.2. OPERATION

General information

- a. Do not operate the machine with defective guards or safety devices that are not present, for example without protections.
- b. Do not put hands or feet near or under the rotating parts. Always keep away from the drain opening.
- c. Do not touch any moving parts of the machine until they have come to a complete stop.
- d. Always wear sturdy shoes and long trousers when operating the machine.
- e. Never lift or transport the machine when the motor is running.
- f. Remove the disabling device from the unit:
 - Before removing an obstruction;
 - Before checking, cleaning or working on the machine;
 - If hit by a foreign object, to check for possible damage to the machine;
 - If the machine starts to vibrate abnormally, check for damage before restarting;

- g. Do not leave the machine in operation unattended in the presence of pets, children or other people nearby.

Maintenance and storage

- a. Tighten all nuts, bolts and screws securely for safe operation of the machine.
- b. Frequently check the robot lawn mower for wear or deterioration.
- c. For safety reasons it is necessary to replace worn out or damaged parts.
- d. Make sure that the blades are replaced only with suitable spare parts.
- e. Make sure the batteries are recharged using the correct charger recommended by the manufacturer. Incorrect use can cause electric shock, overheating or leakage of corrosive liquid from the battery.
- f. In case of electrolyte leaks, wash with water/neutralising agent and consult a doctor in case of contact with the eyes etc.
- g. Machine maintenance must be carried out in accordance with the manufacturer's instructions.

Residual Risks

- Although the product complies with all safety requirements, additional risks may still exist due to improper installation and/or unforeseeable circumstances. Therefore, the area on which the product will operate must be free of objects, people and animals, and all persons who may have access, even occasionally, to the work area must be informed of the possible hazards.
- In the event of thunderstorms with risk of lightning and in anticipation of bad weather conditions in general, it is recommended not to use the product and to disconnect all peripheral devices from the mains. To use the product, reconnect peripherals to the mains following the manual's instructions.

Battery / battery charger



WARNING:

Lithium-ion batteries can explode or cause fires if disassembled, exposed to water, fire or high temperatures or in the event of a short circuit. Handle the battery carefully, do not disassemble it and avoid any type of improper electrical or mechanical stress. Avoid exposing the battery to direct sunlight.

NOTE: It is recommended to use only original products supplied by the manufacturer. Non-original or inadequate products can cause damage to the robot lawn mower or can be dangerous for people, animals and things.

- a. The battery should only be installed and / or removed from the robot lawn mower by the retailer or a service centre.
- b. Store the unused battery in a safe place away from sources of heat or objects that can cause short circuits (pegs, screws, metal objects of various kinds).
- c. Use the battery charger away from flammable surfaces or substances, and in preferably dry places.
- d. Transport the battery and the battery charger in the original packaging.

NOTE: The robot mower battery is a perishable element and the charging capacity decreases over time, decreasing the working range of the robot mower without compromising its operating performance.

Environmental protection

NOTE: Safeguarding the environment must be a relevant and priority aspect of machine use, of benefit to the community and the environment we live in.

- a. Dispose of packaging and damaged parts as required by local regulations in the country of use.
- b. Dispose of electrical equipment (robot lawn mower, battery, power supplies, etc.) as per European Directive 2012/19 / EU and in compliance with the national standards. For further information on the disposal, contact your retailer or a domestic waste collection service.
- c. Separate collection of products and packaging is recommended.

2.3. STOPPING AND TURNING OFF THE ROBOT LAWN MOWER IN SAFE CONDITIONS



OBLIGATION:

Always switch off the robot lawn mower in safe conditions before any cleaning, transport or maintenance operation.

Requirements and obligations:

- Safety key.

Procedure:

1. Press the “STOP” (A) button to stop the robot lawn mower safely and open the protective cover (B).
2. Push the off button (E) for a few seconds and wait for the LED on the same button to go out.
3. Only disengage the safety key (C) after the LED (E) go out to switch off the robot lawn mower in safe conditions.
4. Close the protective cover (B).
5. The robot lawn mower is stopped or switched off in a safe condition.

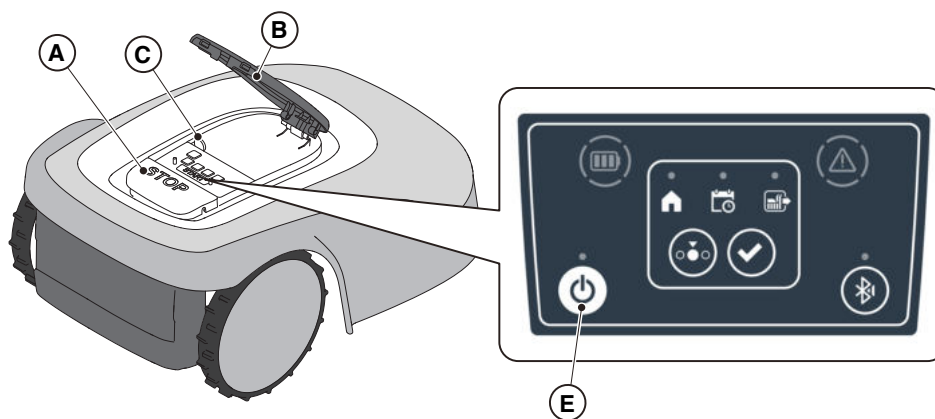

2.4. MOVING THE MACHINE



OBLIGATION:

The robot lawn mower must be safely switched off before being lifted or transported.



WARNING:

Check that there are no toys, tools, branches, clothing, or other items on the lawn that could damage the device.

Procedure:

1. Switch off the robot lawn mower in safety conditions (see par. 2.3).
2. Lift the robot lawn mower by the handle (D) and carry it, taking care to keep the cutting blade away from the body.

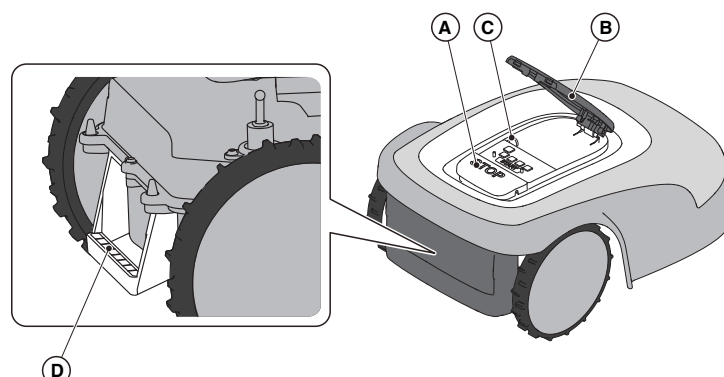

3. INTRODUCTION

3.1. GENERAL INTRODUCTION

3.1.1. PURPOSE OF THE MANUAL

This manual is an integral part of the device and it is intended to provide the information necessary for its use.

Keep this manual for the entire life of the device, so that it is always available in case of need.

The recipient of the manual is the user of the device, who is required to carefully read the information contained therein and apply it rigorously to protect people's safety and to avoid damage.

The information is drawn up in the original language of the manufacturer (Italian) and translated into any other languages for legislative and/or commercial needs.

The following symbols have been adopted to highlight important texts.



DANGER \ CAUTION \ WARNING:

The pictograms contained in a triangle with a yellow background and a black line indicate danger \ caution \ warning.



BAN:

The pictograms contained in a crossed-out circle with a white background and a red stroke indicate a ban.



OBLIGATION:

The pictograms contained in a circle with a blue background indicate an obligation.

NOTE: The texts shown in this form indicate technical information of particular importance, which should not be ignored.

3.1.2. INSTRUCTIONS FOR READING FROM SMARTPHONE

For better readability of the user manual, it is recommended to keep the smartphone in an horizontal position, as shown in the picture.

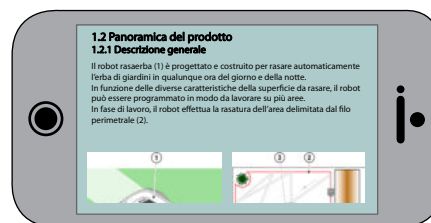
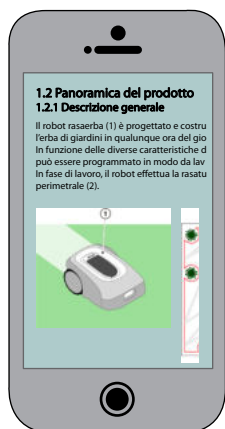

3.2. PRODUCT OVERVIEW

3.2.1. GENERAL DESCRIPTION

The robot lawn mower (A) is designed and built to automatically cut garden grass at any time of day and night.

According to the different characteristics of the surface to be cut, the robot lawn mower can be programmed to work on several areas delimited by a virtual perimeter and connected by virtual transition routes.

When operating, the robot lawn mower mows the area delimited by the virtual boundary (B) When the robot lawn mower is close to the virtual boundary (B) or encounters an obstacle (C) it changes its trajectory according to the chosen navigation strategy.

The robot lawn mower mows the delimited lawn automatically and completely.

The product works using a satellite signal and requires the installation of a charging base (F) with an integrated satellite reference station (G), which can also be installed separately. The robot lawn mower and the satellite reference station communicate with each other via 3G/4G modules fitted with SIM cards. The operating technology of the robot lawn mower is based on data communication between STIGA Cloud and the robot itself. The subscription fee for SIM card data traffic is included for the entire useful life of the product and does not entail any additional costs. A smartphone is also required for the product to be used. Any other usage may be hazardous and harm persons and/or damage things. Improper use includes (for example, but not limited to): transporting people, children or animals on the machine; being transported by the machine; using the machine to pull or push loads; using the machine for cutting non-grass vegetation.

NOTE: the presence of a mobile network connection at the installation site is mandatory for operation of the robot mower. Check in advance that the mobile network coverage is sufficient on stiga.com or via the APP. The network connection provider may change at any time according to commercial agreements.

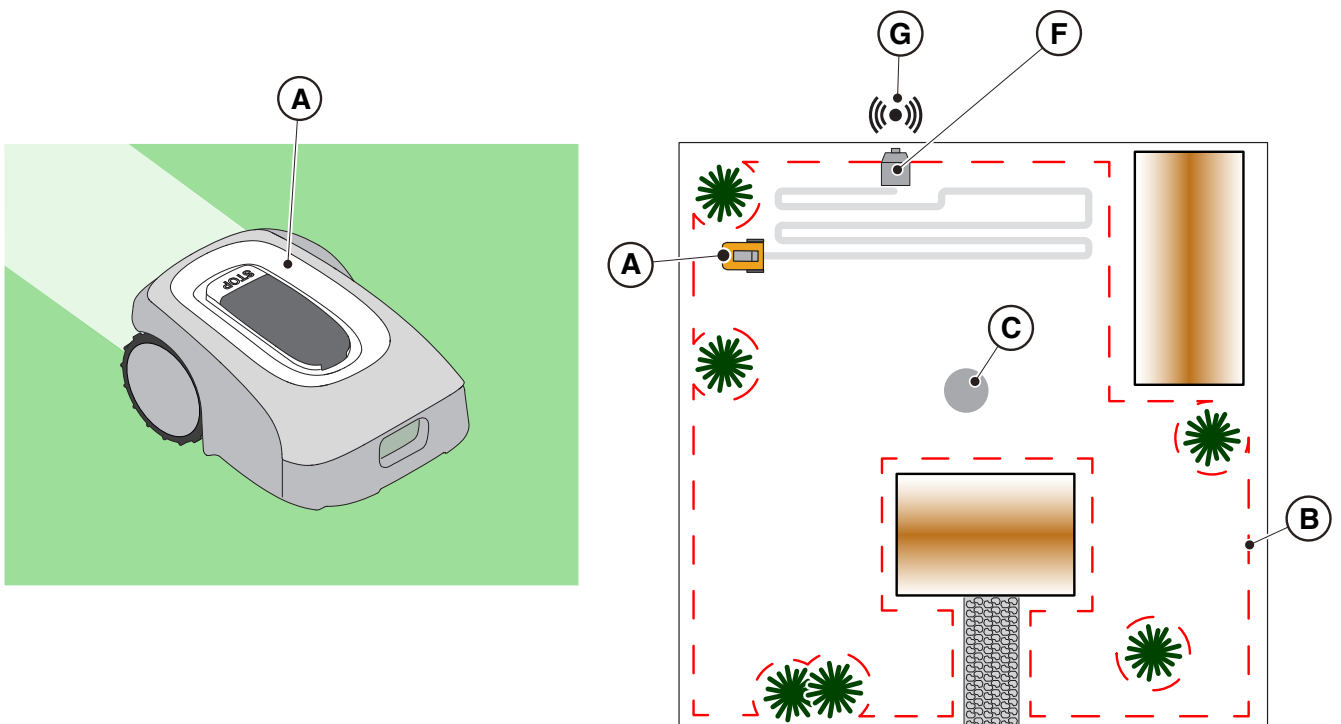

3.2.2. MAIN COMPONENTS

- (A) Robot lawn mower
- (B) Battery/ies (depending on the model)
- (C) charging base
- (D) Satellite reference station (inside the charging base)
- (E) charging base power supply

- (F1) Instruction manual
- (F2) Fixing screws for the charging base
- (F3) Blister with blades and fixing screws
- (F4) App Lock label
- (F5) Safety key
- (F6) Mounting bracket, clevis fastener and screws
- (F7) 5 m extension cable

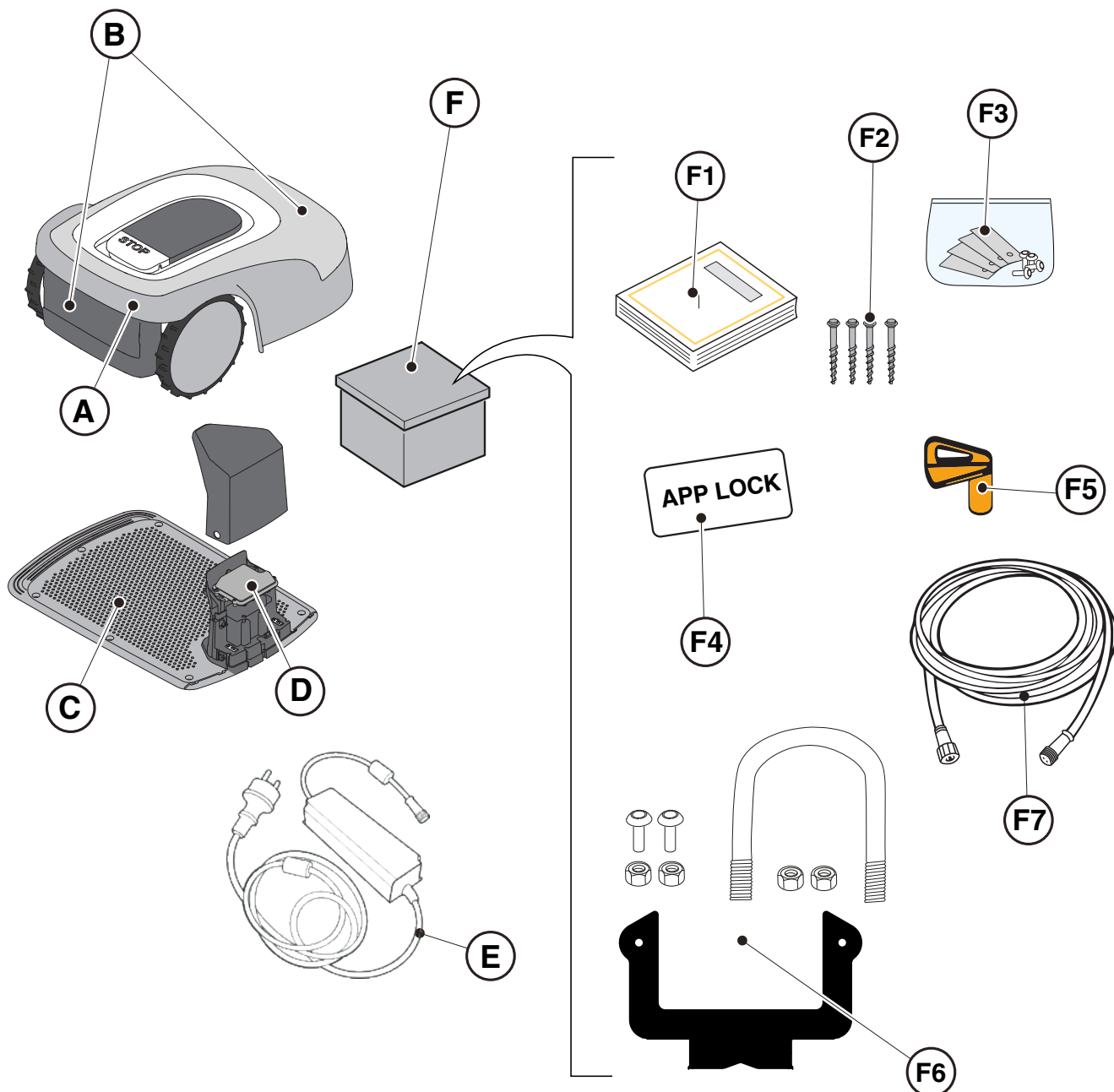

3.3. UNPACKING

Following are listed all the steps to perform the correct unpacking:

1. Open the box of the robot lawn mower;
2. Take out the power supply box;
3. Take out the upper containment carton;
4. Take out the robot lawn mower;
5. Take out the charging base.



WARNING:

Make sure to remove all packaging material from the robot lawn mower before using it.



WARNING:

To avoid injury or damage, please be careful when unpacking the robot lawn mower, avoiding contact with cutting blades or other hazardous elements.

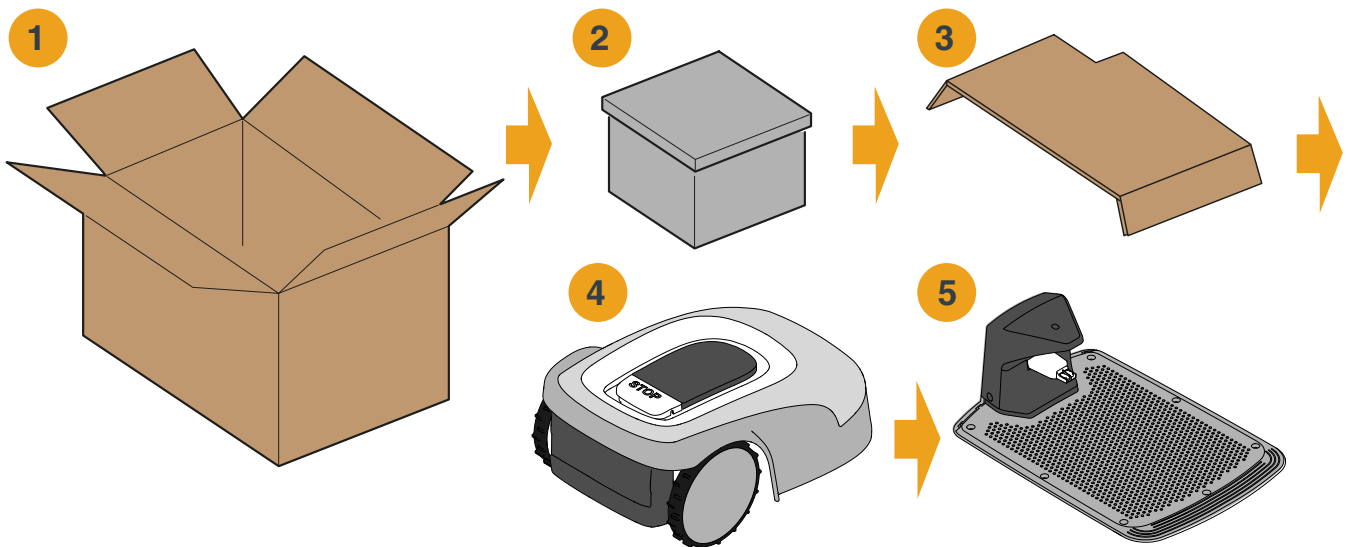

3.4. SYMBOLS AND NAMEPLATES

Symbols on the safety label:

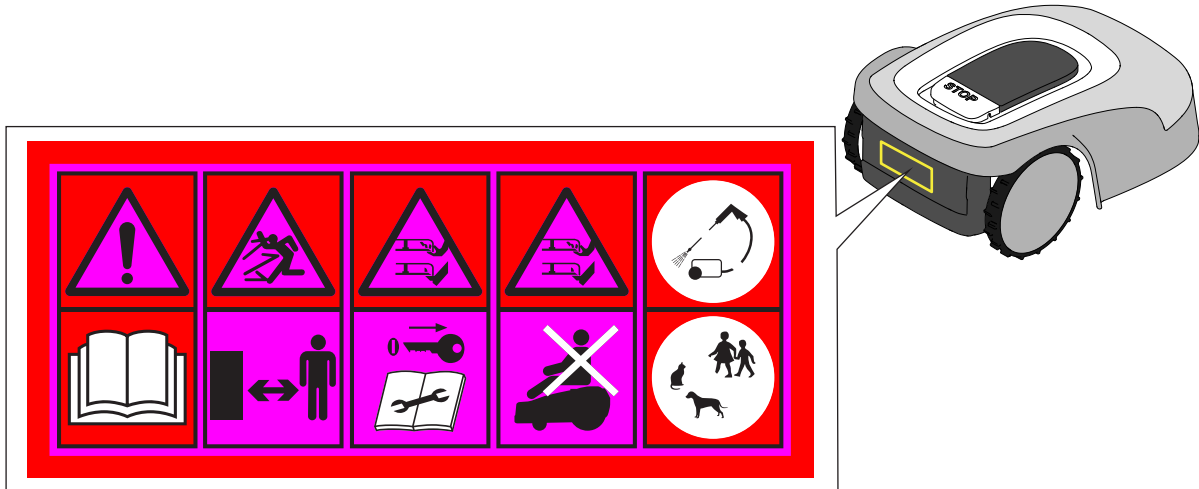

WARNING:

Read the user instructions before starting the product.



WARNING:

Danger of projections of objects against the body.

Keep an adequate safe distance from the machine while it is running.



WARNING:

Do not put hands and feet near or under the opening of the cutting means.

Remove the disabling device before operating on the machine or before lifting it.



WARNING:

Do not put hands and feet near or under the opening of the cutting means.

Do not stand on the machine.



BAN:

Do not use high pressure cleaners on the machine to clean or wash it.



BAN:

Make sure that there are no people (especially children, elderly or disabled) and pets in the working area during the operation of the machine.

Keep children, pets and other people at a safe distance when the machine is functioning.

Symbols on model labels:



Appliance with insulation class III, powered by battery (Robot Lawn mower) or special power supply unit (Charging Base and Reference Station).



Use the original power supply with the specifications on the rating plate.



DC power supply symbol.

IPXX

Protection rating against the ingress of solids and water.



Electrical and Electronic Equipment Waste, to be taken to designated facilities for recycling and disposal.



Guaranteed sound power level

All the symbols on the Battery are shown below:

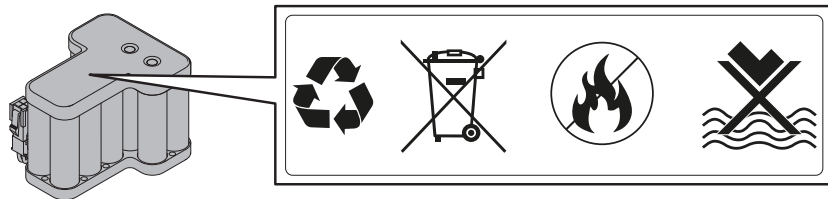

WARNING:
Read the user instructions before starting the product.



Do not dispose of the battery as normal household waste.
Dispose of the battery in the appropriate authorized collection centres.



Do not throw the battery into the fire and do not expose it to heat sources.



Do not immerse the battery in water and do not expose it to moisture.

3.5. GENERAL MANUAL READING INSTRUCTIONS

The criteria used for the preparation of this document are described below.

1. Topic title (A).
2. Requirements and equipment for carrying out the procedure (B).
3. Description of the procedure (C).
4. Descriptive pictures of the procedure (D).

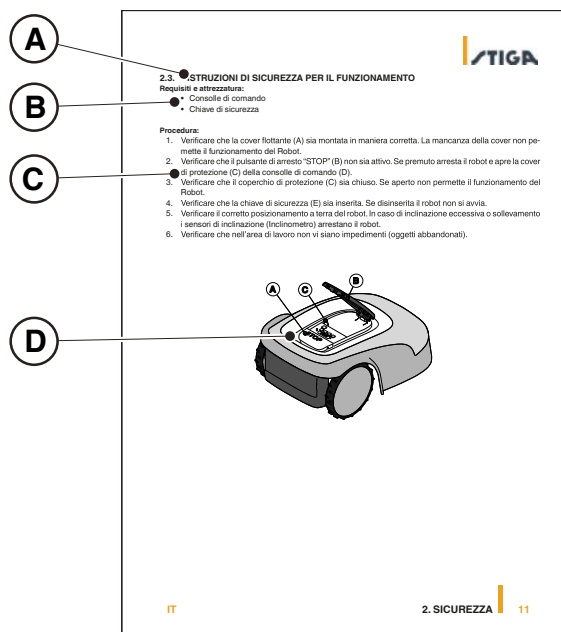

4. INSTALLATION

4.1. GENERAL INSTALLATION INFORMATION



CAUTION:

Do not modify, tamper with, elude or eliminate the safety devices installed.

NOTE: For further clarification on the installation of the product please contact a STIGA dealer.

4.2. INSTALLATION COMPONENTS

- (A) charging base
- (B) Power supply
- (C) Reference Satellite Station
- (D) Fixing screws for the charging base
- (E) Bracket for the separate fastening of the satellite reference station
- (F) Power Supply for the separate installation of the Reference Satellite Station (optional)
- (G) 5m extension cable
- (H) Mobile device (not included)

See Chapter 9 “Accessories”

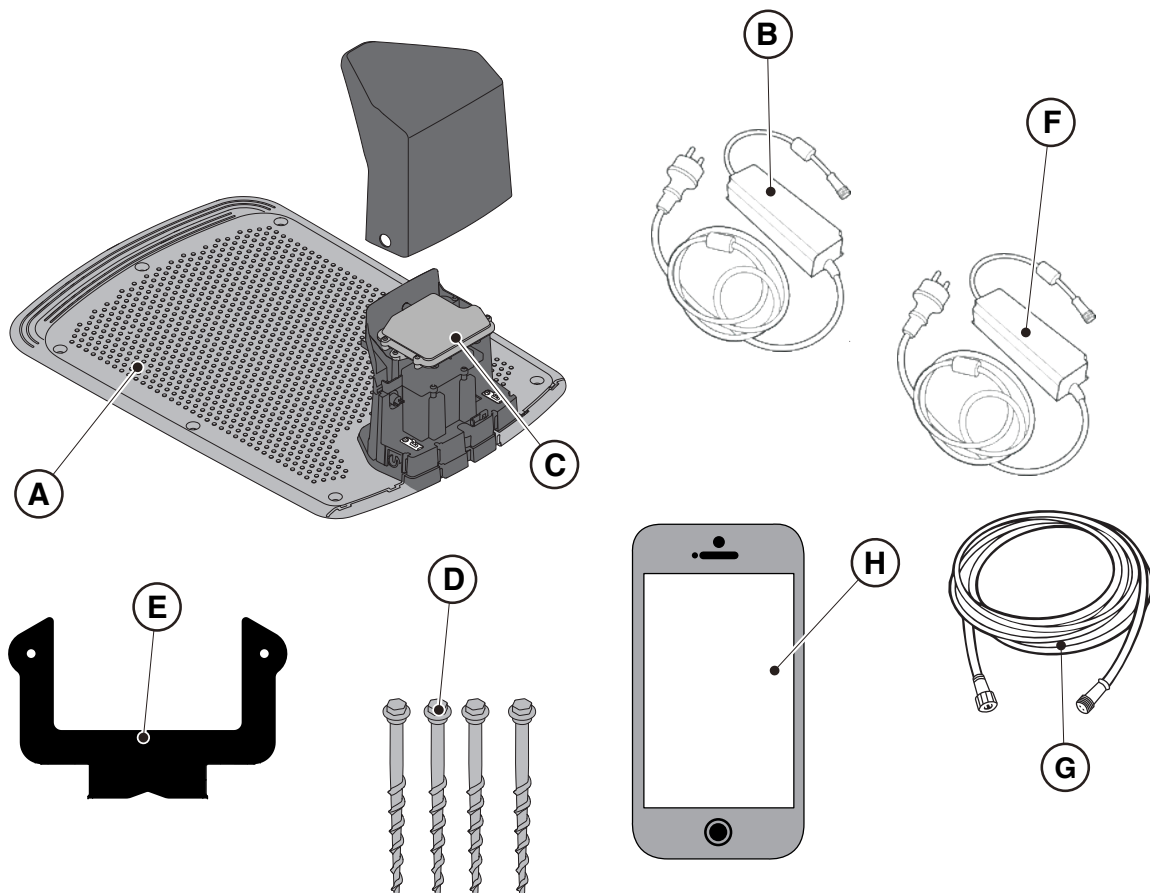

4.3. VERIFICATION OF THE INSTALLATION REQUIREMENTS

Below, the procedures to check the necessary requirements and prepare the garden before proceeding with the installation are described.

4.3.1. GARDEN VERIFICATION:



- Carry out a survey of the entire area for a correct detection of the state of the garden, of any obstacles and areas to be excluded.
- Check whether the lawn to be mowed is even, free of holes, stones or other obstacles and if necessary carry out any necessary remediation work.
- Level the ground to prevent puddles from forming after a rainfall.
- At the first installation, the initial height of the grass must be within the operating range of the robot lawn mower: 20-60mm. If necessary, prepare the garden using a traditional lawn mower.

The robot lawn mower works using a satellite signal. The accuracy of the satellite signal can be affected by:

- The presence of obstacles around the perimeter of the installation or within the work area, such as: trees with dense foliage, hedges, boundary walls, metal fences, buildings and reflective surfaces such as glass or metal walls.
- Adverse weather conditions, such as dense fog, dense cloud cover, heavy rainfall or snowfall.

In the event of any malfunction, move the satellite reference station to another area free of obstacles and/or exclude the area from the work area of the robot lawn mower.

4.3.2. CHECKS FOR THE INSTALLATION OF THE CHARGING BASE AND POWER SUPPLY:

 <p>ELECTRICAL HAZARD: A socket must have been prepared near the installation area to connect it to electricity. Make sure that connection to the power supply network conforms to laws in force of the Country where it is used.</p>	 <p>ELECTRICAL HAZARD: Do not connect the power supply to an electrical outlet if the plug or the cable is damaged. Do not connect or touch a damaged cable before it is disconnected from the power supply. A damaged cable can lead to contact with live parts.</p>
 <p>ELECTRICAL HAZARD: The circuit provided must be protected by a residual current device (RCD) with an activation current not exceeding 30 mA.</p>	

Procedure:

- Provide a flat surface to position the charging base (A). The charging base must be installed in a location that can be reached by the satellite signal, preferably in an area of the garden where the sky is fully visible and near an electrical socket.
- Make sure that the space for installing the charging base is sufficient, in order to have an obstacle-free zone at least 2 metres wide and at least 3 metres long in front of it. The ground must be perfectly flat and compact in order to avoid deformation of the surface of the charging base.



WARNING:

The power cable (B), power supply unit, extension cord and all other electric cables which do not belong to the product must remain outside the cutting area to maintain their distance from hazardous moving parts and prevent damage to cables which may come into contact with live parts.

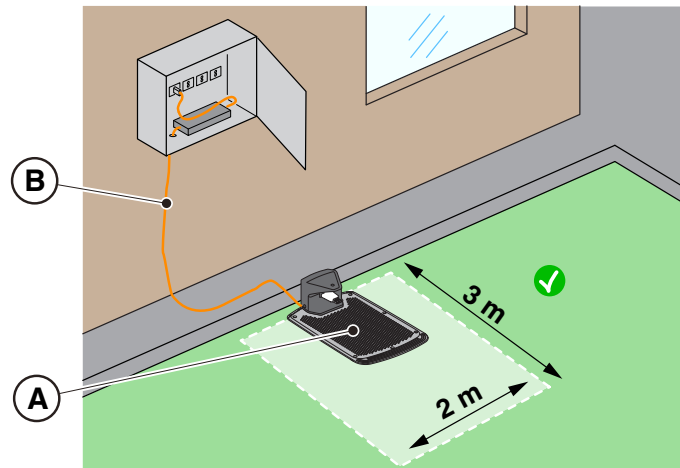

• The return to the base of the robot lawn mower takes place via a virtual return path, which includes a manoeuvring zone extending 1 m to the right and 1 m to the left of the recorded path (A), and 50 cm behind the docking station (B). The following minimum distances between the manoeuvring area and the various garden elements must be observed:

- 30 cm from obstacles confined by virtual perimeters or no-cut zones (C)
- 30 cm from fixed obstacles without confines or continuous structural elements (D);
- 1m from public roads (E);
- 1m from pools (F);
- 1m from footpaths (G);
- 1m from cliffs or steep slopes (H).

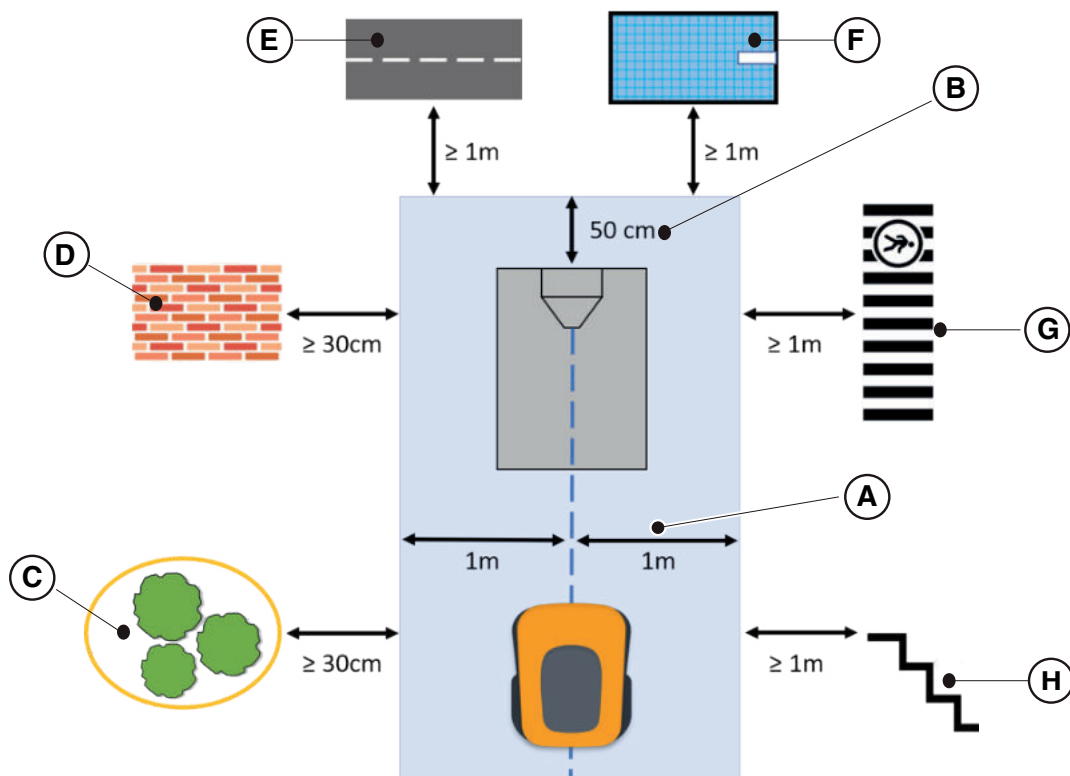

- If it is not possible to comply with the above mentioned distances, the virtual return path and the area behind the docking station must be delimited with impassable barriers (I), if not already in place.
- The docking station's power cable must be routed outside the cutting area.

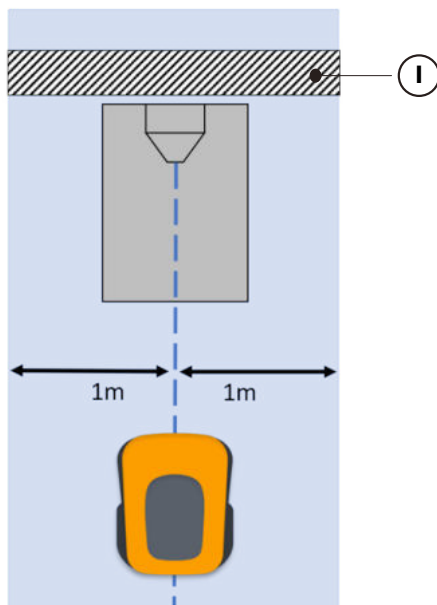

- When exiting the charging base, the robot mower normally rotates 180° immediately after disengaging from the charging contacts. In some special cases, where it is strictly necessary to install the docking station:
 - in proximity of vertical structures that may reduce the quality of the satellite signal.
 - in areas where manoeuvring is restricted, which must be delimited by impassable barriers in any case.

It is possible to activate a long reverse manoeuvre (Long Exit) via the app. In this case, the robot lawn mower performs a reverse manoeuvre of 2 m in length before rotating 180°, so that it is better located both for performing the manoeuvre as well as receiving the satellite signal.

The long reverse function (Long Exit) is to be considered as an aid in certain special installation conditions, and under no circumstances should it be used to install the docking station under canopies or inside closed rooms.

NOTE: In some cases, after the 2 metre reverse manoeuvre, the robot lawn mower may still find itself in sub-optimal satellite signal reception conditions. In this case, the docking station must be installed elsewhere.

- The charging base (A) with satellite reference station (B) must be positioned in an area where the sky is fully visible. If obstacles such as dense foliage trees, hedges, boundary walls, metal fences, buildings and reflective surfaces like glass or metal walls are present, the charging base with satellite reference station must be installed away from these disturbing elements, in a position where the sky is fully visible.

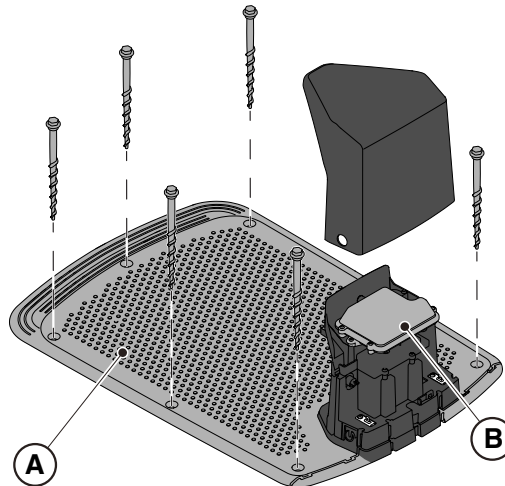

NOTE: The sky is considered fully visible when clear at an angle of at least 120 degrees in all directions.

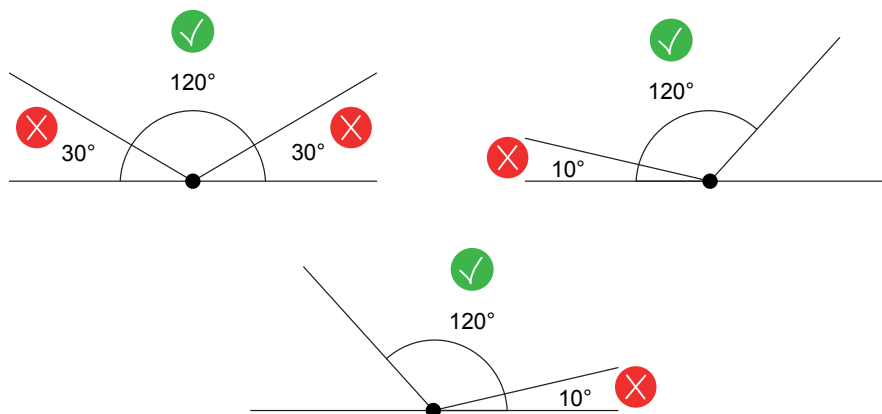

- If the charging base (A) with satellite reference station (B) is not positioned in an area where the sky is fully visible, the satellite reference station (B) must be removed from the charging base (A) and installed in an area where the sky is fully visible. The satellite reference station (B) must be positioned above disturbing elements such as dense foliage trees, hedges, boundary walls, metal fences, buildings and reflective surfaces such as glass or metal walls. The connection to an electrical outlet may be required (see Par. 4.5.2).

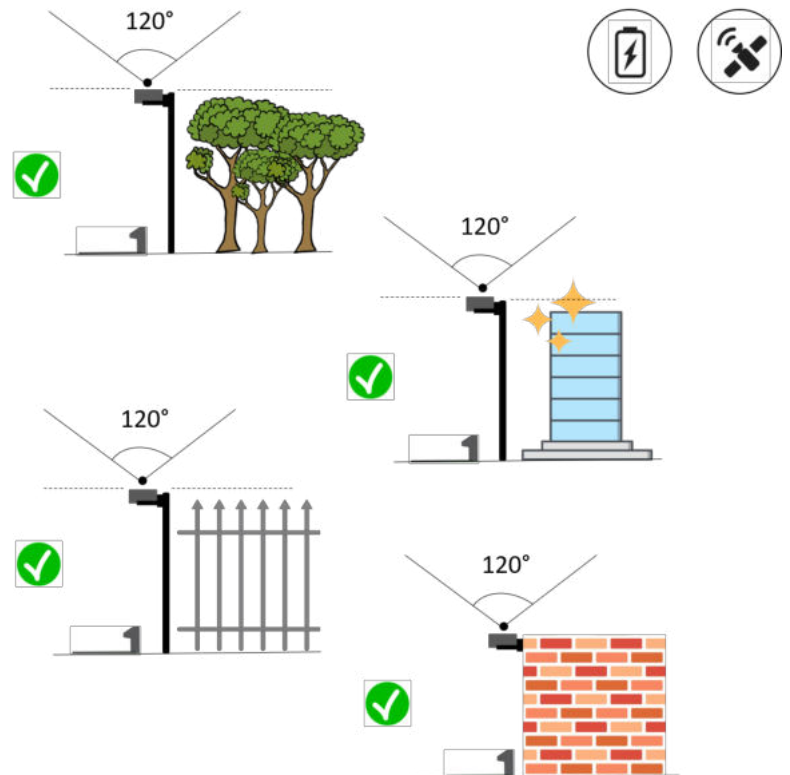
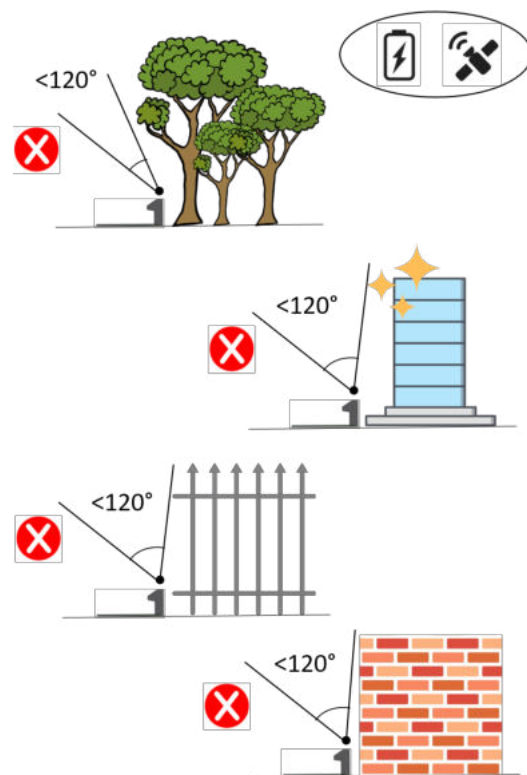
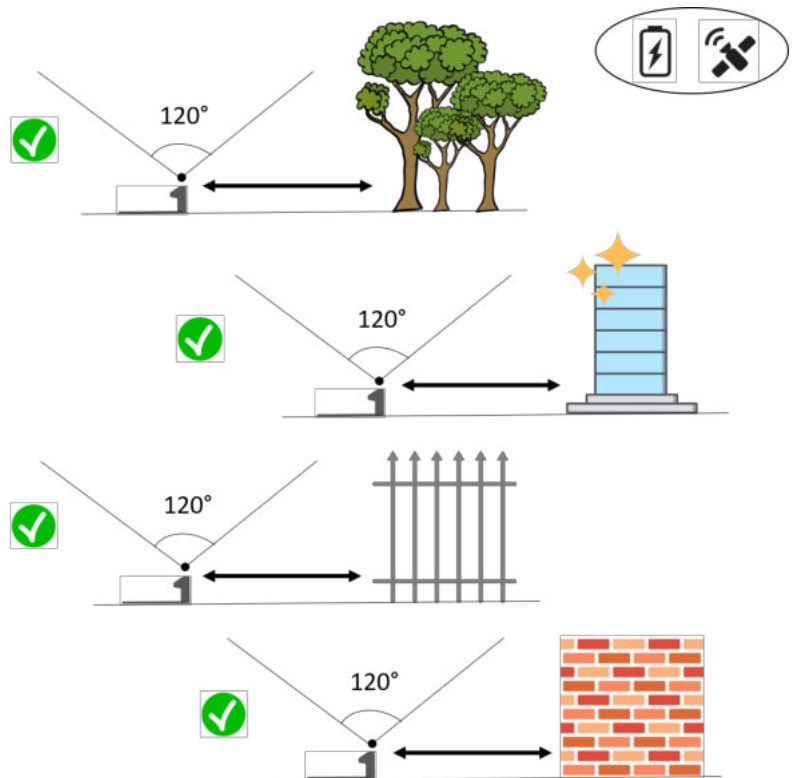
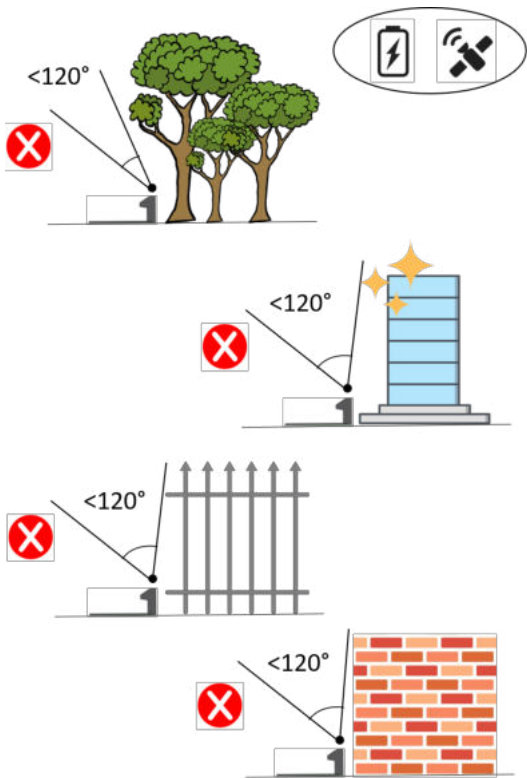

- Make sure that the area chosen for installing the charging base (D) is at least 400 cm away from the charging base (E) of a possible second robot lawn mower.



WARNING:

The excessive proximity between two charging bases could cause interference.

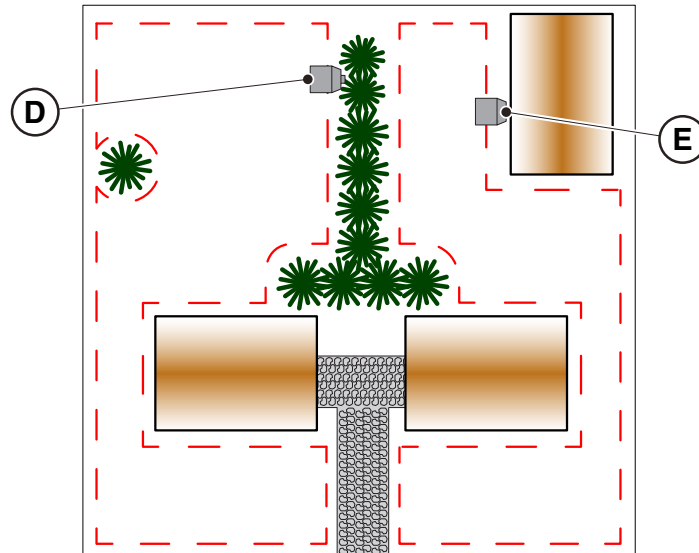

- Prepare the installation area of the power supply unit (B) so that it is protected from solar radiation and in order to prevent it from being submerged in water at any time.

NOTE: It is preferable and recommended to install the power supply (B) in a closed compartment protected from atmospheric agents, in a position that is not easily accessible by unauthorized persons such as children ($X > 160$ cm).

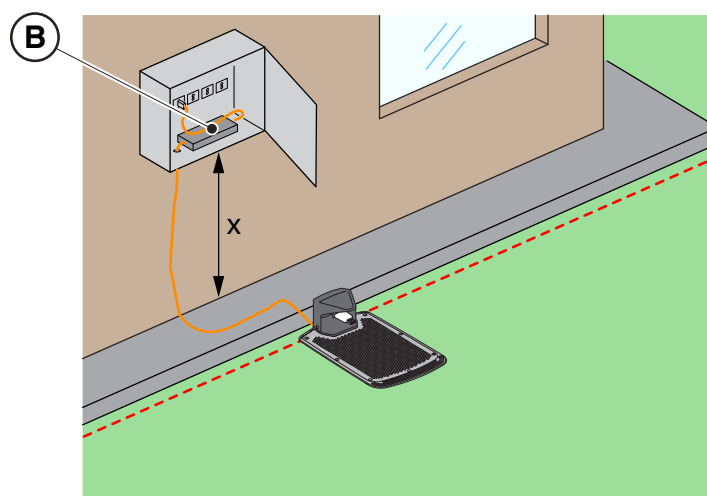

4.3.3. CHECKS TO DEFINE THE VIRTUAL PERIMETERS:

1. Check that the maximum slope of the work area is less than or equal to 45% or 50% depending on the model (see Par. 1.2 TECHNICAL DATA). For the definition of virtual boundaries, please comply with the rules shown in the following images:
 - a) if the slope is $\leq 20\%$, the virtual boundary can be positioned as shown;
 - b) if the slope is $> 20\%$ and $\leq 45\%$ (50%) the installation must include the slope area observing the distance indicated in the image;
 - c) if the slope is $> 20\%$ and the slope area is not part of the part of the garden to be cut, the distance indicated in the image must be observed;
 - d) if the slope is $> 45\%$ (50%) the slope area must be excluded observing the distance indicated in the image.

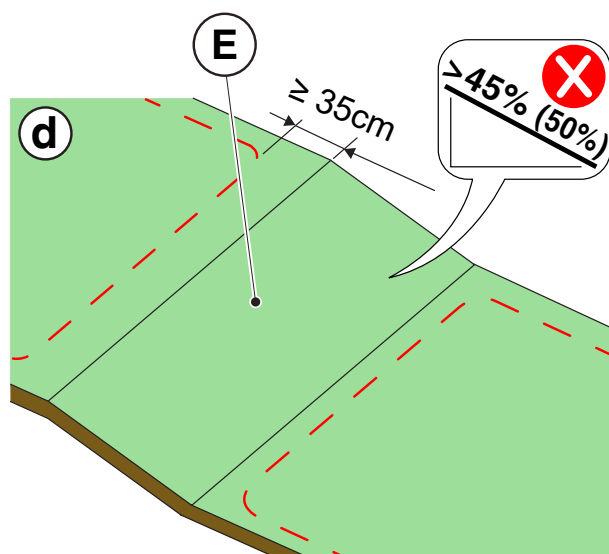
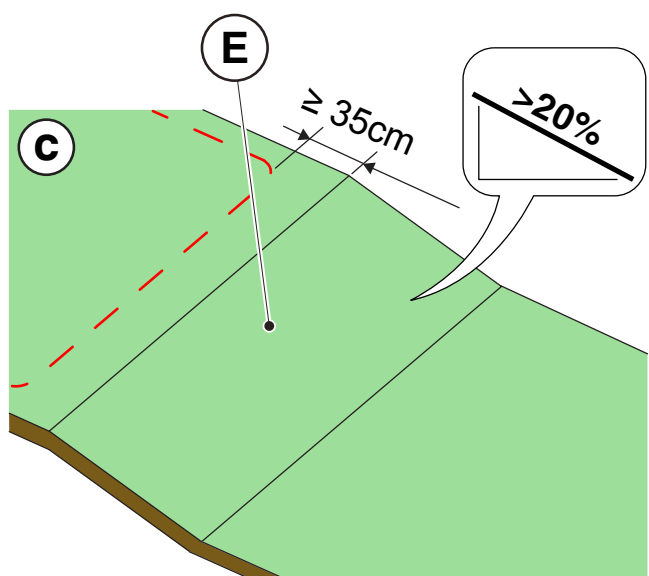
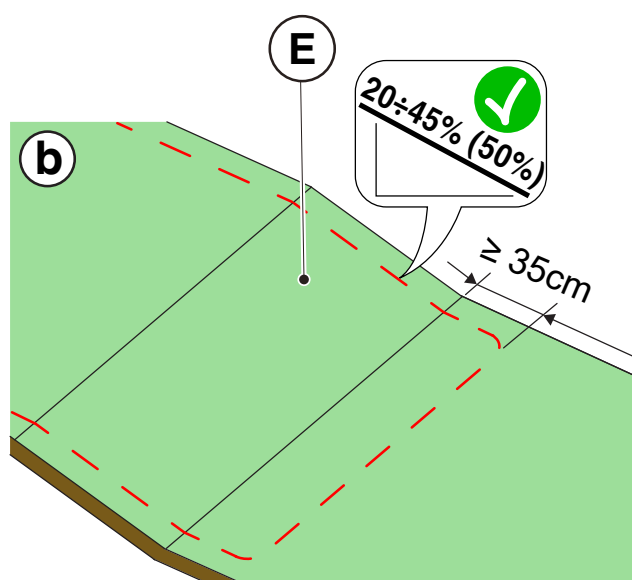
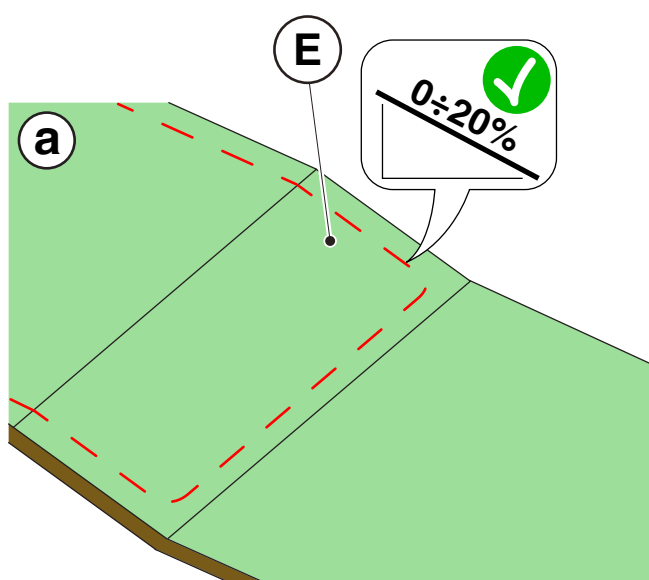



WARNING:

The robot can mow surfaces with a maximum slope of 45% or 50% depending on the model. In case of non-compliance with the instructions, the robot may slip and exit the work area.



WARNING:

Areas with slopes greater than those permissible may not be mowed. Position the virtual perimeter before the slope, excluding that area of lawn from the mowing.

2. Check the entire work surface: assess the obstacles and areas to be excluded from the work area (F), which must be programmed as areas to be avoided (G).

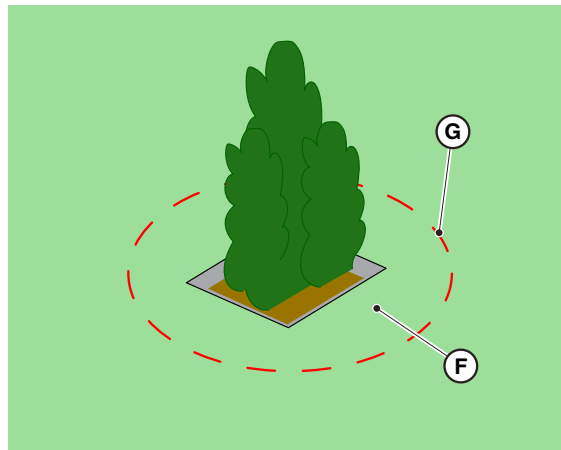

4.4. CRITERIA FOR DELIMITING WORK AREAS AND TRANSITION ROUTES

4.4.1. MINIMUM VIRTUAL BOUNDARIES AND DELIMITATION DISTANCES

Procedure:

1. If there is a pavement or driveway (A) at the same level as the lawn, the virtual boundary can coincide with the edge of the pavement. It is also possible to programme the virtual boundary by guiding the robot lawn mower over the edge of the pavement.
2. In the presence of a swimming pool, pond or excavated areas (B), the virtual perimeter must be programmed at a distance of at least 1 meter. If the pool, pond or excavated area are positioned at the end of a slope, the virtual perimeter must be programmed at a distance of at least 1.5 meters
3. In the case of trees with protruding roots (C), the virtual boundary must be programmed in such a way as to prevent the robot lawn mower from crossing over uneven surfaces.
4. The virtual perimeter must be programmed so that the robot lawn mower is kept at a distance of at least 30 cm from areas with gravel or small stones (D)
5. In the case of sloping areas, follow the instructions provided in par. 4.3.3.
6. In the case of continuous structural elements (walls, fences, hedges, etc.) higher than 50 cm, the virtual boundary must be programmed at a minimum distance of 40 cm from them (E).
7. In all other cases, the virtual boundary can be determined according to the size of the machine, considering a minimum distance of 30 cm between the robot lawn mower and the obstacle (F).
8. In the case of delimitation of obstacles less than 150 cm apart (G), delimit them as a single obstacle respecting the distances indicated above.



CAUTION:

The operating area and more generally the area in which the robot lawn mower can travel must be cordoned off by fencing.



WARNING:

If the slope is greater than 45% or 50%, depending on the model, the slope area must be excluded from the cutting area (See Par. 4.3).

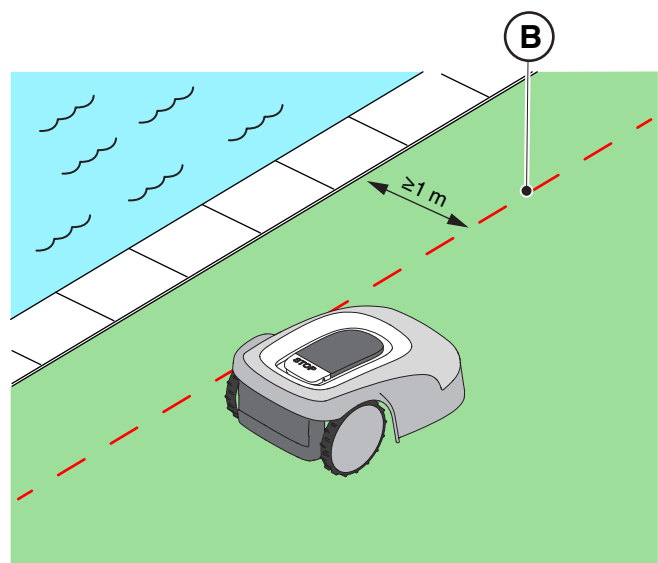
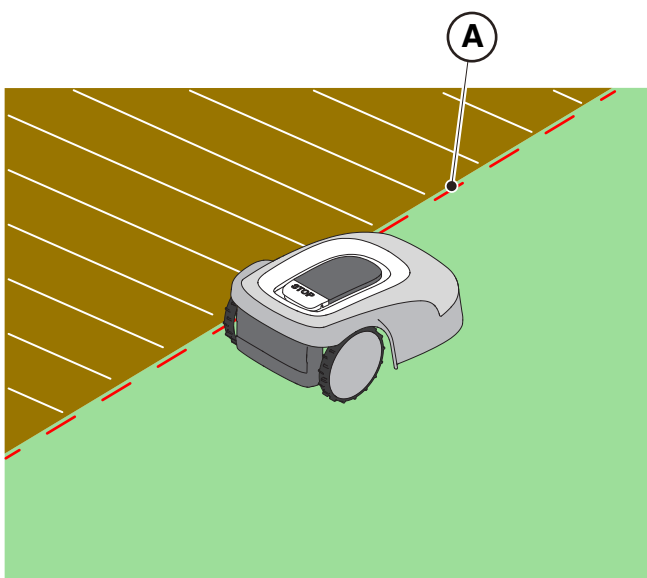

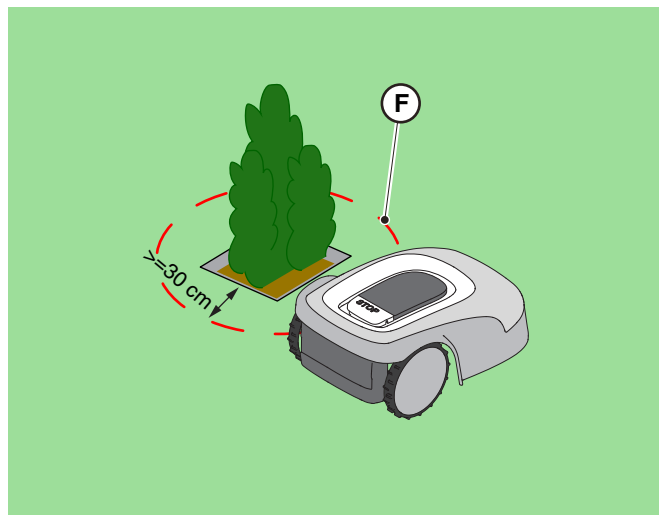
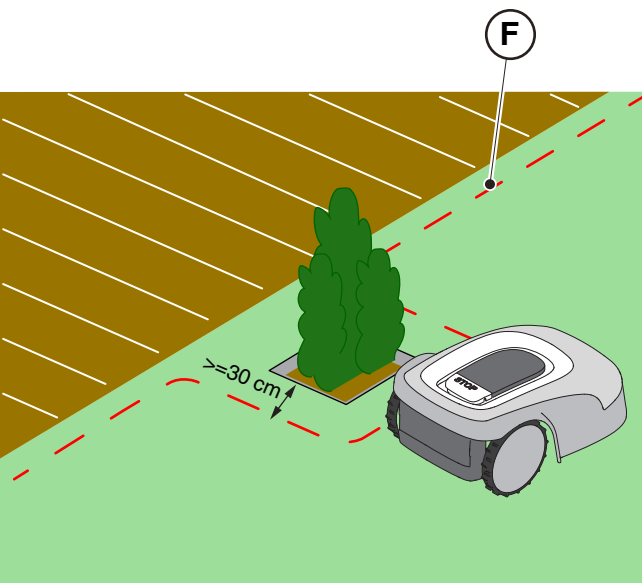
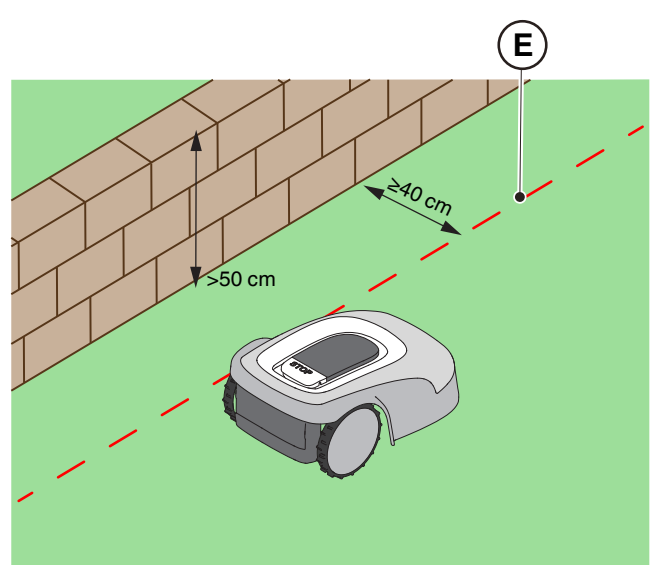
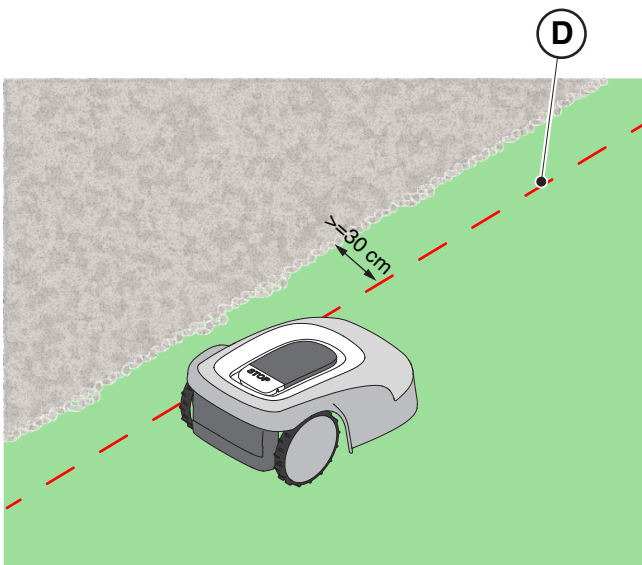
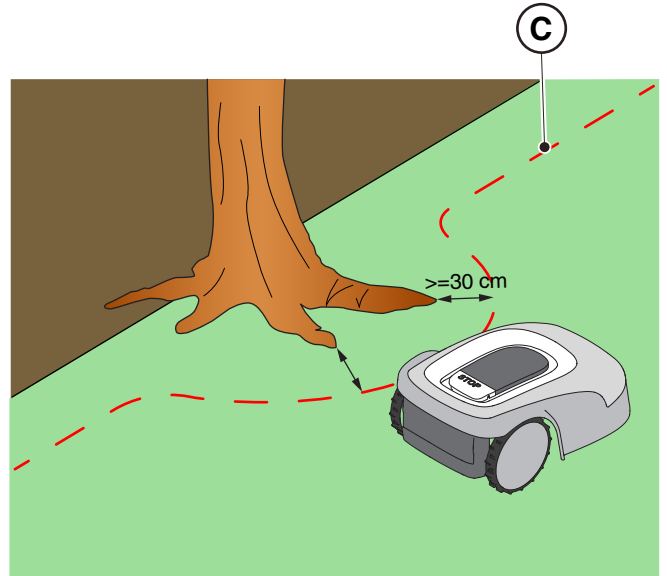
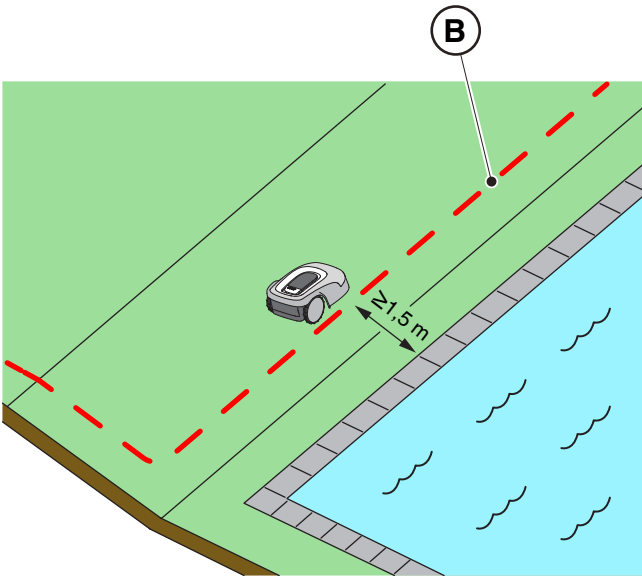

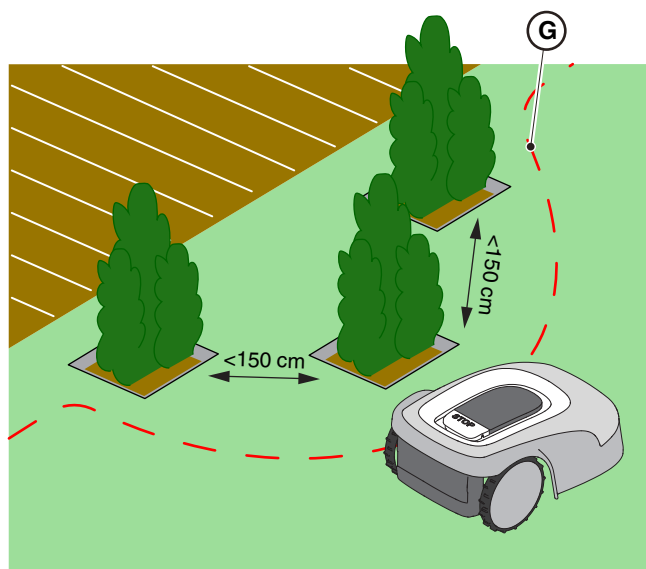

4.4.2. NARROW PASSAGES

Procedure:

1. In the case of narrow passages, the distance between two different virtual perimeters must be $Z \geq 2$ m (A).
2. In the case of a passage where the distance between the virtual boundaries would be < 2 m, the part of the area beyond the bottleneck (A) cannot automatically be reached by the robot lawn mower. In this case, it is necessary to programme two separate virtual cutting zones (B) and connect them with a virtual transition route (C).
3. If it is not possible to connect the two areas with a virtual transition route, the part of the area beyond the bottleneck (A) is to be considered a 'Closed Area' (see Par. 4.4.3).

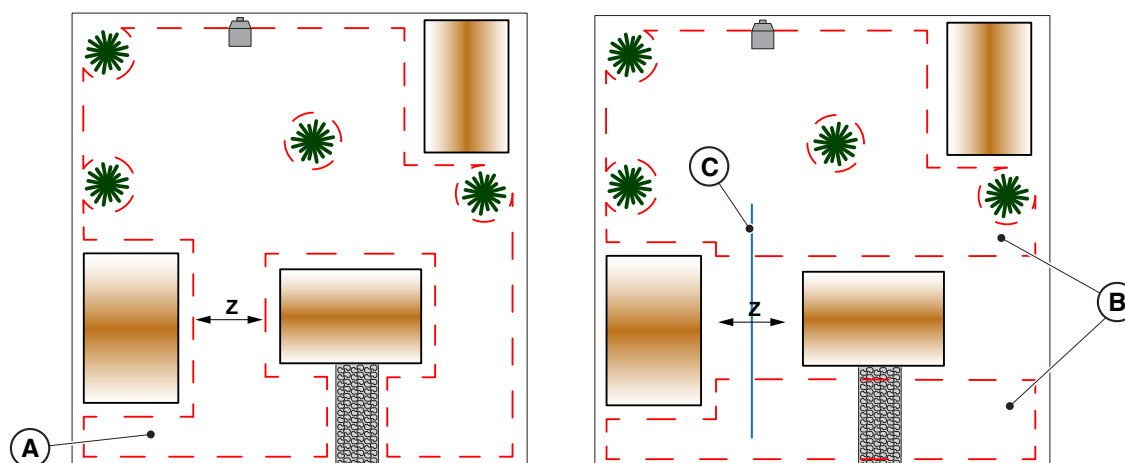

4.4.3. CLOSED AREAS

Areas that cannot be reached independently by the robot lawn mower via a virtual transition route must be programmed as 'Closed Area' (option in App).

Each Closed Area can have a maximum surface area depending on the model (see technical data table). If it is necessary to cover a larger area than the maximum manageable by a single Closed Area, subdivide the area into several Closed Areas.

To program closed areas, follow the same criteria as in Par. 4.4.1.

The robot lawn mower must be brought by hand into each closed area and started manually.

4.4.4. TRANSITION ROUTES

If there are areas of the garden that are separated from each other by areas that should not be mowed or where there is no lawn, e.g. hard surfaces that are at the same level as the garden, it is possible to connect the areas to be mowed using transition routes. The robot lawn mower will move from one area to another with the cutting device switched off.

The transition route may be used also to reach the charging base when it is not installed within a working area.

Procedure:





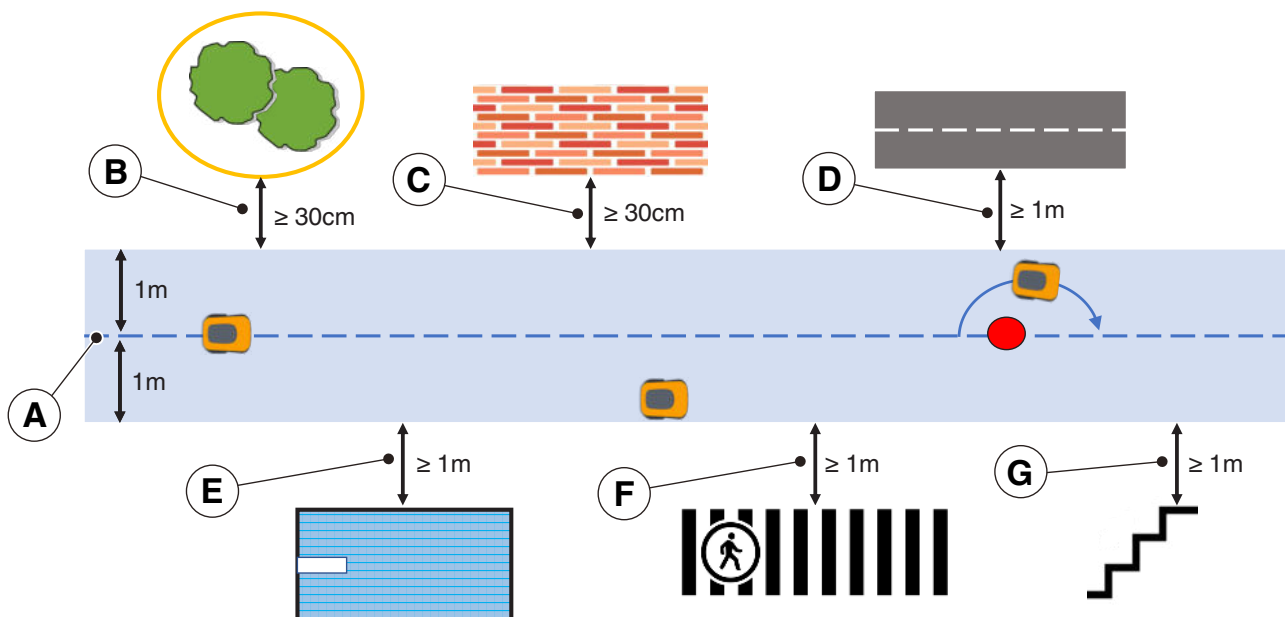

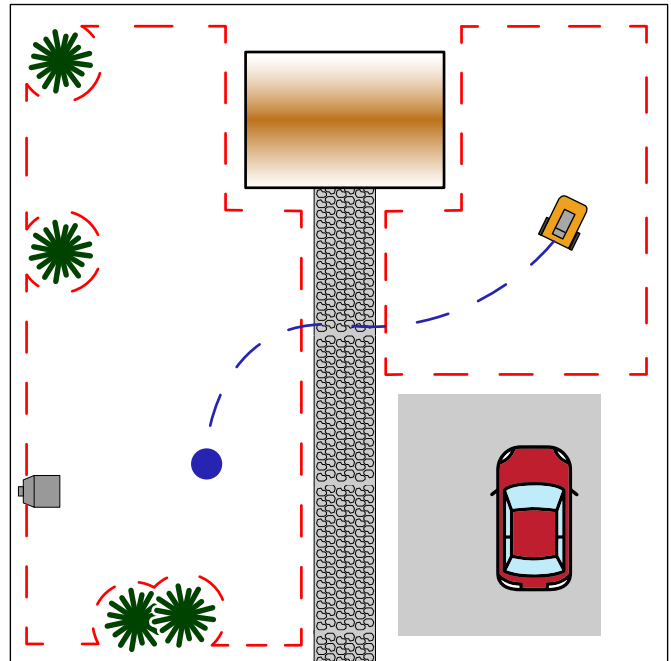
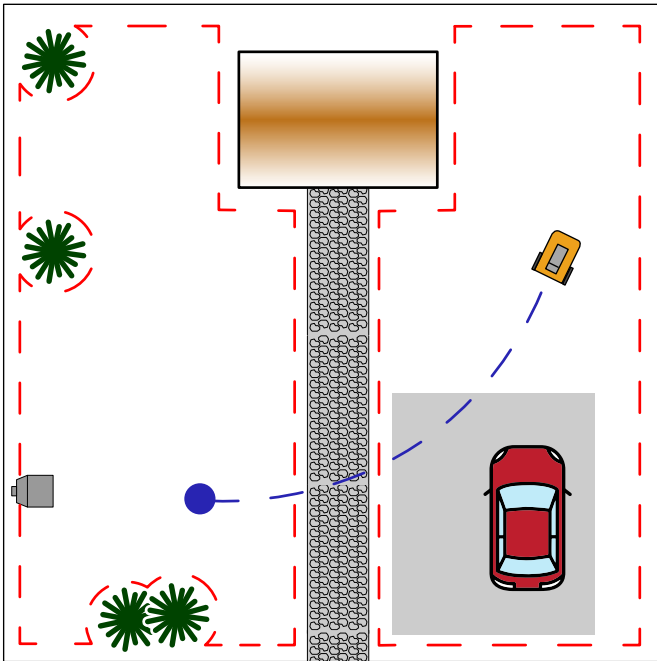

1. Assess the possible routes and choose the easiest transition route that allows the robot to maintain the furthest distance from any obstacles and that does not cross areas usually used for parking or the transit of vehicles or pedestrians.
2. The transition route includes a manoeuvring zone extending 1 m to the right and 1 m to the left of the programmed route (A). The following minimum distances between the manoeuvring area and the various garden elements must be observed:
 - 30 cm from obstacles confined by virtual perimeters or no-cut zones (B)
 - 30 cm from fixed obstacles without confines or continuous structural elements (C);
 - 1 m from public roads (D);
 - 1 m from pools (E);
 - 1 m from footpaths (F);
 - 1 m from cliffs or steep slopes (G).
3. Transition routes must respect the maximum slope limit of 20%.
4. In the case of narrow passages where the above distances cannot be met, the passage must be cordoned off by fencing, if not already present.

NOTE: Transition paths programmed within narrow passages may have inadequate satellite signal reception, affecting the robot lawn mower's operating accuracy.





4.5. COMPONENTS INSTALLATION

 <p>ELECTRICAL HAZARD: Only use the battery charger and power supply provided by the manufacturer. Improper use may cause electric shock and/or overheating.</p>	 <p>CAUTION: The circuit provided must be protected by a residual current device (RCD) with an activation current not exceeding 30 mA.</p>
 <p>ELECTRICAL HAZARD: A socket must have been prepared near the installation area to connect it to electricity. Make sure that connection to the power supply network conforms to laws in force of the Country where it is used.</p>	 <p>ELECTRICAL HAZARD: Connect the power supply only at the end of all the installation operations. If necessary during the installation, turn off the general power supply.</p>
 <p>CAUTION: Danger of cutting hands.</p>	 <p>CAUTION: Danger of dust in the eyes.</p>
 <p>GLOVES OBLIGATION: Use protective gloves to avoid cutting your hands.</p>	 <p>GLASSES OBLIGATION: Use safety glasses to avoid the danger of dust in the eyes.</p>

4.5.1. INSTALLATION OF THE CHARGING BASE

	CAUTION: Danger of cutting hands.		CAUTION: Danger of dust in the eyes.
	ELECTRICAL HAZARD: Connect the power supply only at the end of all the installation operations. If necessary during the installation, turn off the general power supply.		

Requirements and obligations:

- Flat land
- Charging base
- Power supply
- Glasses
- Compact soil
- Fixing screws
- Gloves

	GLOVES OBLIGATION: Use protective gloves to avoid cutting your hands.		GLASSES OBLIGATION: Use safety glasses to avoid the danger of dust in the eyes.
--	---	--	---

The charging base can be installed inside the work area or in an area connected to it by a transition route.

Make sure that the space for installing the charging base is sufficient, in order to have an obstacle-free zone at least 1.5 metres wide and at least 3 metres long in front of it.

Procedure:

1. Check the installation requirements as indicated in par. 4.3.
2. If necessary, prepare the ground so that the surface of the charging base (A) is at the same level as the lawn (B), the ground must be perfectly flat and compact in order to avoid deformation of the surface of the charging base.

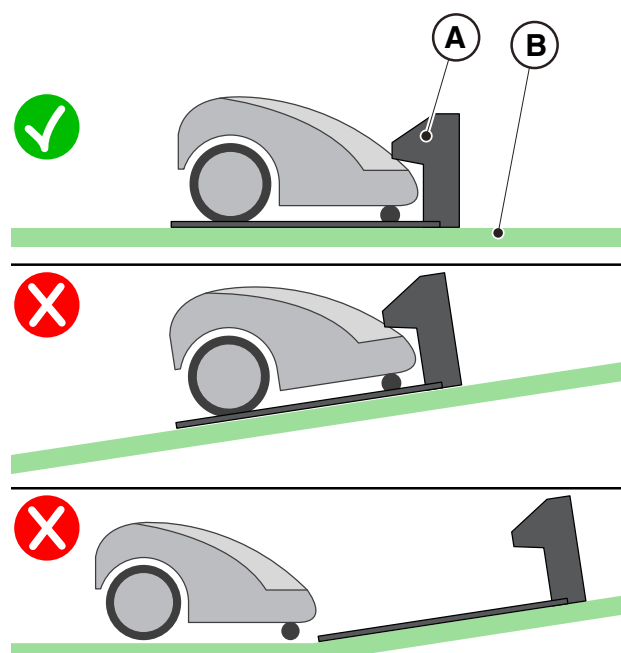

3. Secure the charging base (L) to the ground with the fixing screws (M).
4. Check whether the satellite reference station (A) is connected to the charging base through its connector:
5. Connect the power supply unit to the charging base and screw in the connector.
6. Connect the power supply plug to the electrical outlet.
7. When the robot lawn mower is not in the charging base, make sure that the indicator light on the charging base (N) is lit (see Par. 5.4).



WARNING:

The power cable, power supply unit, extension cord and all other electric cables which do not belong to the product must remain outside the cutting area to maintain their distance from hazardous moving parts and prevent damage to cables which may come into contact with live parts.

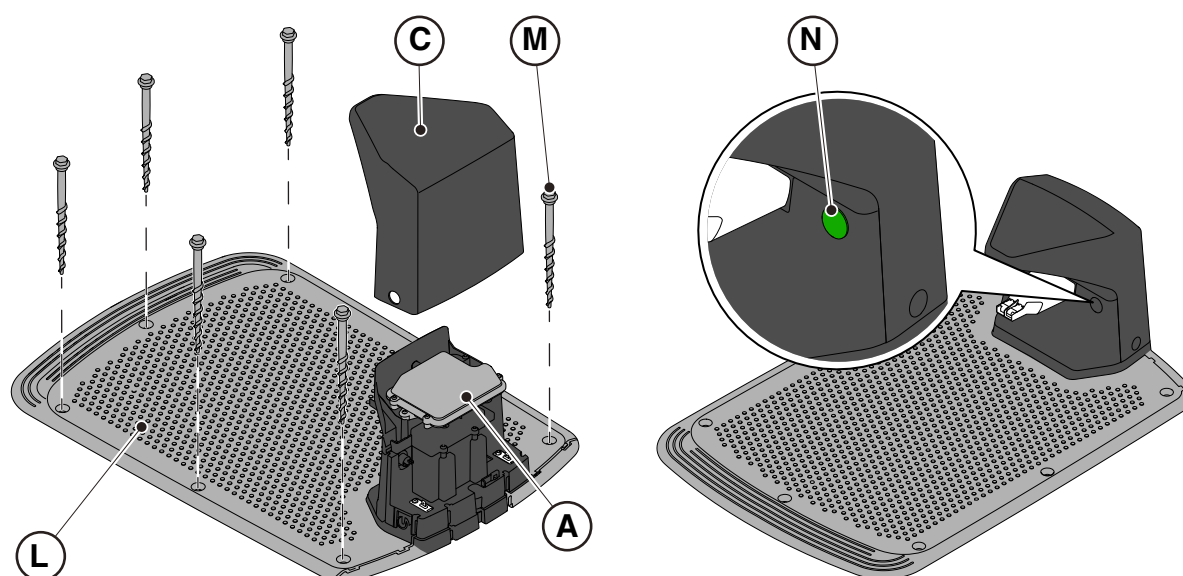





NOTE: If necessary, it is possible to extend the power cable to the charging base by using the extension cables. It is permitted to use a maximum of two 5-metre extension cables or one 15-metre extension cable (See Chap. 9 "Accessories").



WARNING:

The robot lawn mower needs to receive the satellite signal even while it is inside the charging base. If a protective cover is to be installed over the charging base, only original STIGA covers should be used. Do not, under any circumstances, install metal covers over the charging base.

4.5.2. INSTALLING THE SATELLITE REFERENCE STATION

 <p>ELECTRICAL HAZARD: Only use the battery charger and power supply provided by the manufacturer. Improper use may cause electric shock and/or overheating.</p>	 <p>CAUTION: The circuit provided must be protected by a residual current device (RCD) with an activation current not exceeding 30 mA.</p>
 <p>ELECTRICAL HAZARD: A socket must have been prepared near the installation area to connect it to electricity. Make sure that connection to the power supply network conforms to laws in force of the Country where it is used.</p>	 <p>ELECTRICAL HAZARD: Connect the power supply only at the end of all the installation operations. If necessary during the installation, turn off the general power supply.</p>

The satellite reference station (A) is supplied with the charging base and is installed under the protective cover (B).

It is powered by the charging base through a connector (C).

If the charging base (D) is not positioned in an area where the sky is fully visible, the satellite reference station (A) must be removed from the charging base and installed in an area where the sky is fully visible. In this case, the installation of the satellite reference station (A) must be carried out using the mounting bracket (E). To supply power it is possible to use:

- a 5 metre extension cable (L) (included);
- a 15-metre extension cable that can be purchased separately (L);
- a separately purchased power supply unit (F) and the connection to an electrical outlet.

If the reference station is installed separately, a minimum installation height of 2.5 metres above the ground is recommended.

Prepare the installation area of the power supply unit (F) so that it is protected from solar radiation and in order to prevent it from being submerged in water at any time.



WARNING:

The power cable, power supply unit, extension cord and all other electric cables which do not belong to the product must remain outside the cutting area to maintain their distance from hazardous moving parts and prevent damage to cables which may come into contact with live parts.



WARNING:

The power supply cable and power supply unit must be positioned in an area where they do not pose any danger to children, persons or animals.



CAUTION:

For safety reasons, the satellite reference station must never be moved after the programming of the virtual perimeters, transition routes and areas to be avoided. The robot lawn mower could exit the programmed work area. If the reference station is moved, the programming must be repeated.

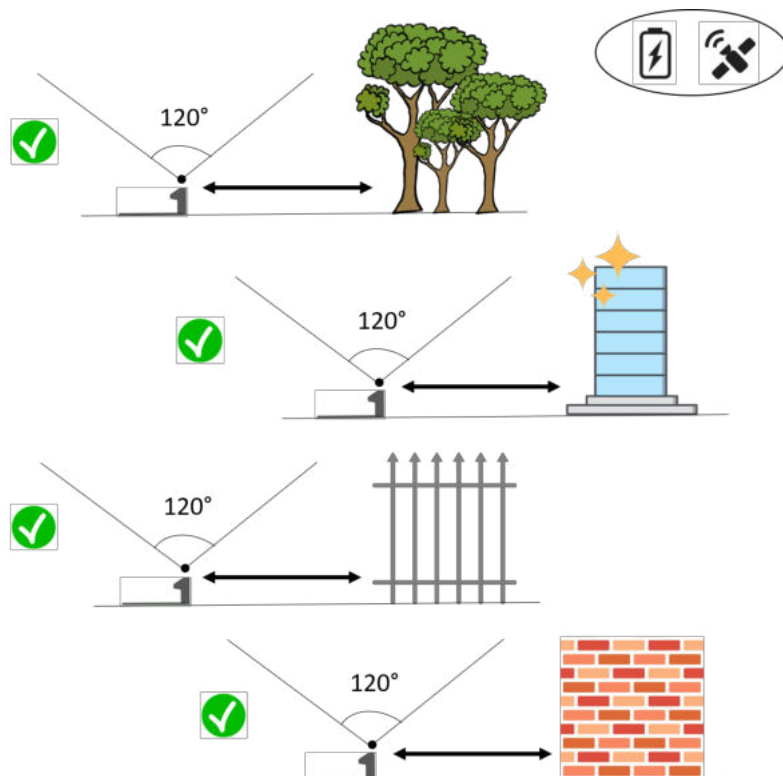
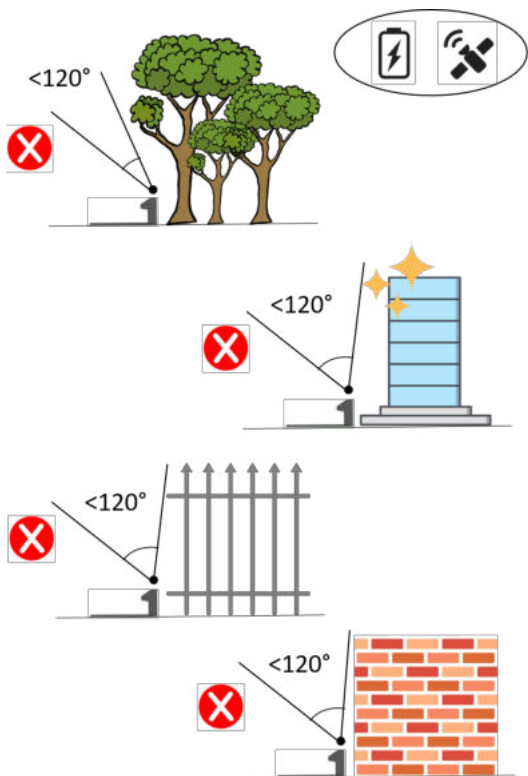
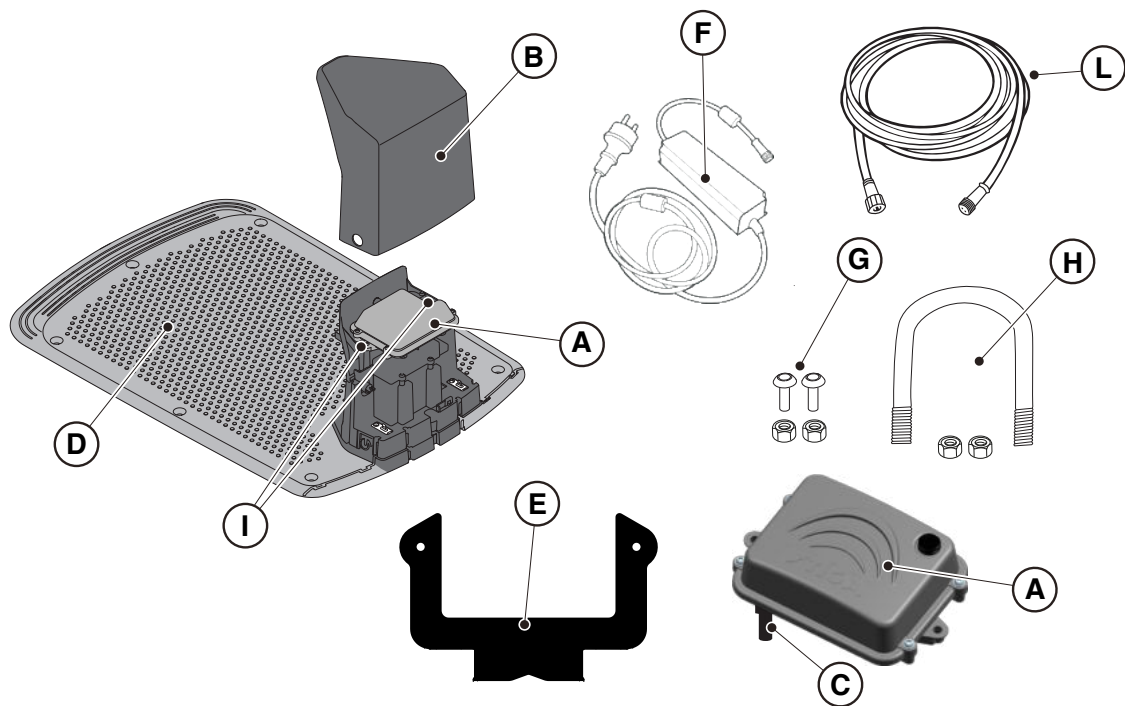

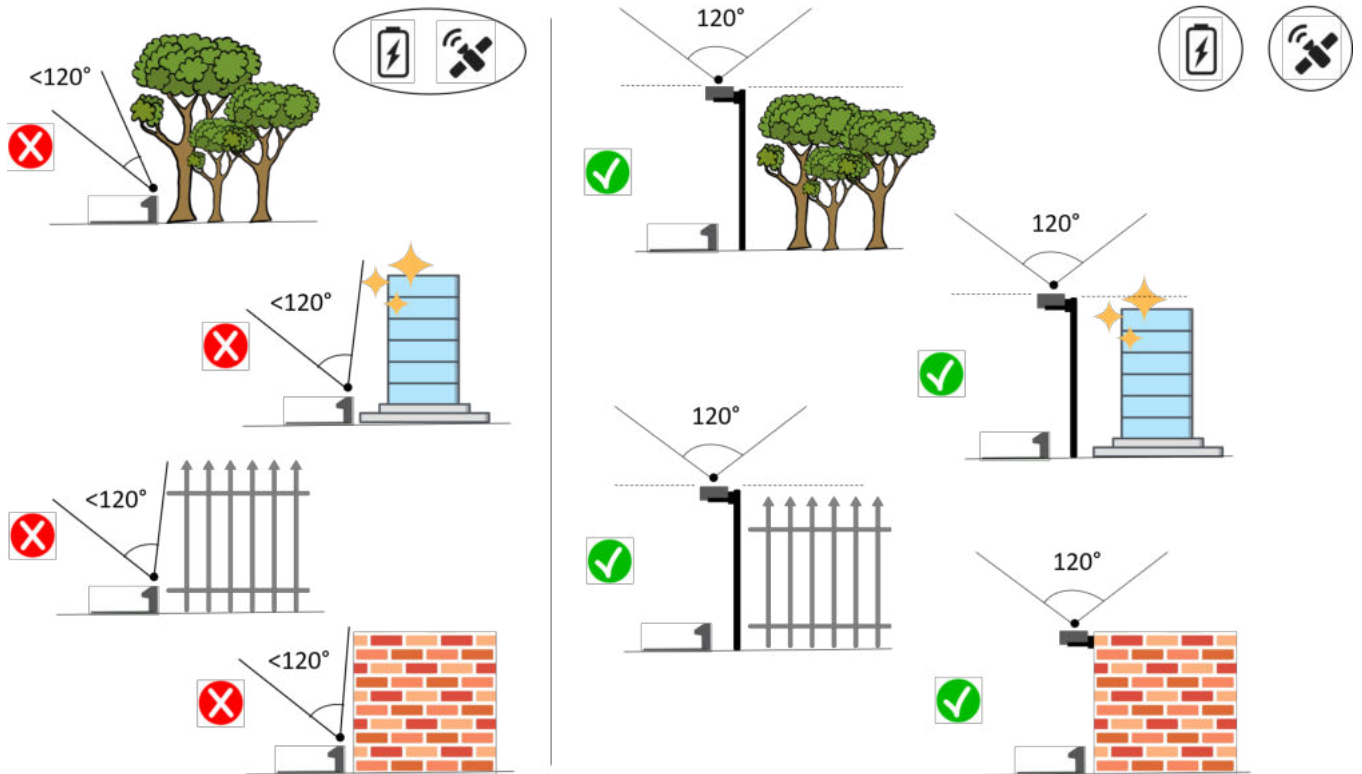

Requirements and obligations:

- Satellite reference station (A).
- 5 metre extension cable (L) (included).
- or 15-metre extension cable (to be purchased separately) (L).
- Or power supply unit (F) (to be purchased separately).
- Mounting bracket (E)
- Screws for fixing the satellite reference station to the bracket (G).
- Clevis fastener for fixing the bracket to a pole (H) or screws for wall mounting (not included).

Requirements and obligations:

1. Check the installation requirements in Par. 4.3.2.
2. Open the cover (B).
3. Disconnect the connector (C) of the satellite reference station (A) from the charging base (D).
4. Unscrew the fixing screws (I) and remove the satellite reference station (A) from the charging base (D).
5. Fasten the bracket (E) to a wall (N) using the fixing screws (not included), making sure it is level. When mounting on a pole (M), use the included clevis fastener (H) to secure the bracket (E).
6. Secure the satellite reference station (A) to the bracket (E) with the connector (C) facing downwards using the screws (G). Make sure the station is in a perfectly horizontal position. An installation height of at least 2.5 metres above the ground is recommended.
7. Connect the satellite reference station to the power supply unit (F) or extension cable using the connector (C) and tighten the ring nut.
8. Secure the power cable to prevent it from being damaged or posing a danger.
9. Connect the plug of the power supply unit (F) to the electrical socket. If an extension cable is being used to supply power to the satellite reference station, connect the cable to the free connector on the charging base and tighten the ring nut.

NOTE: The top of the satellite reference station should be as close as possible to the top of the wall or the pole.

NOTE: If necessary, it is possible to extend the cable powering the satellite reference station using extension cables. It is permitted to use a maximum of two 5-metre extension cables or one 15-metre cable (See Chap. 9 “Accessories”).

NOTE: To avoid any interference, the satellite reference station must be installed at least 400 cm away from other satellite reference stations that may be in the vicinity.

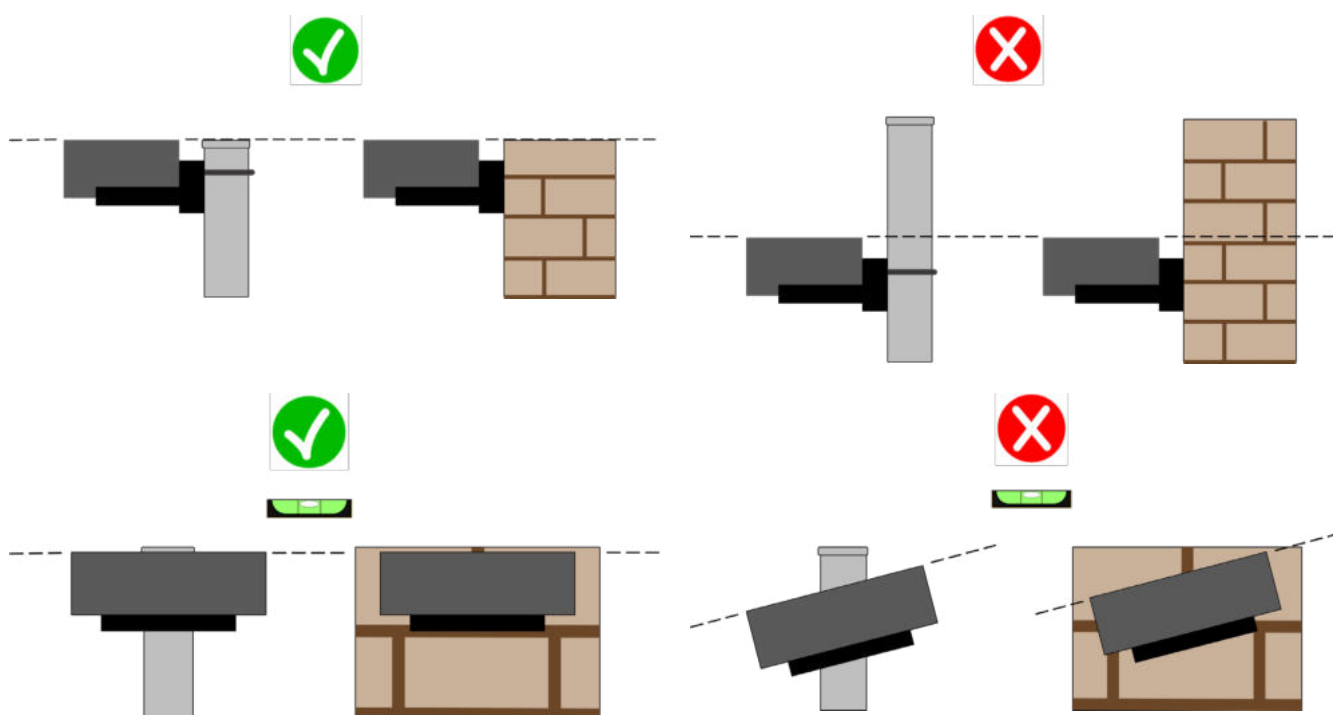
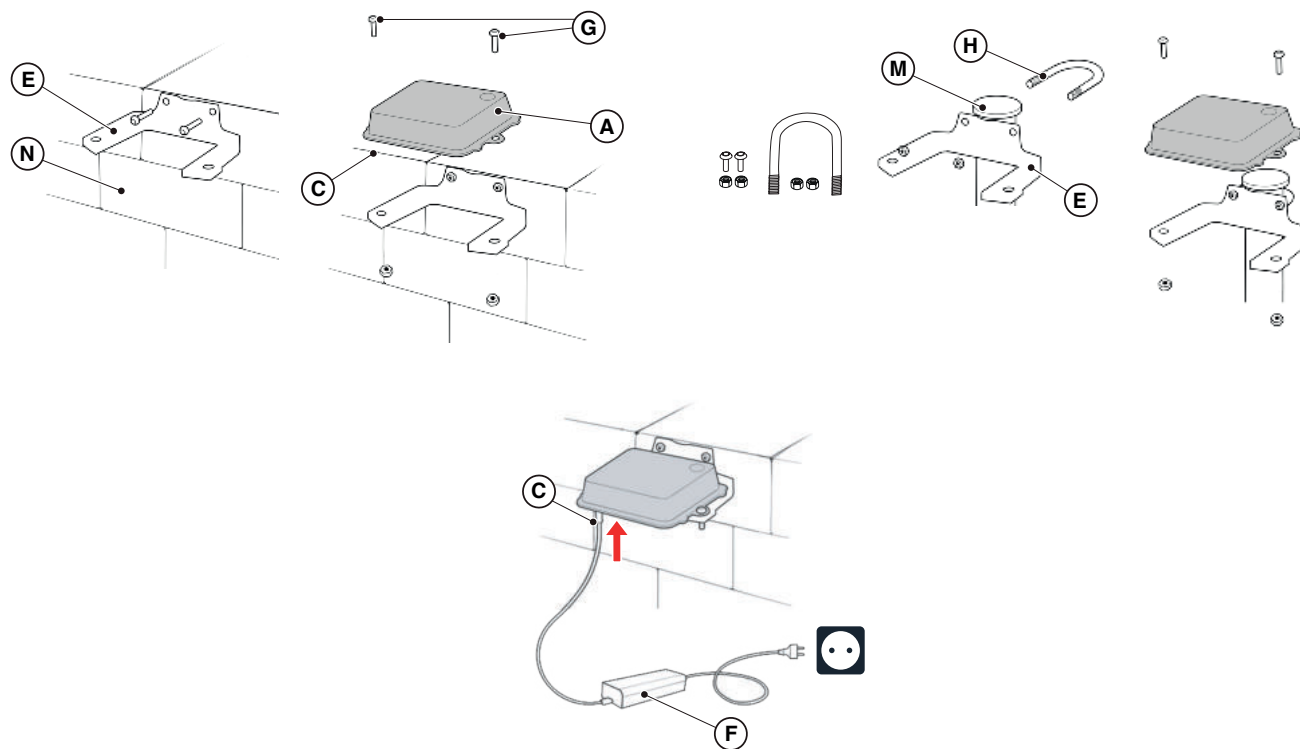

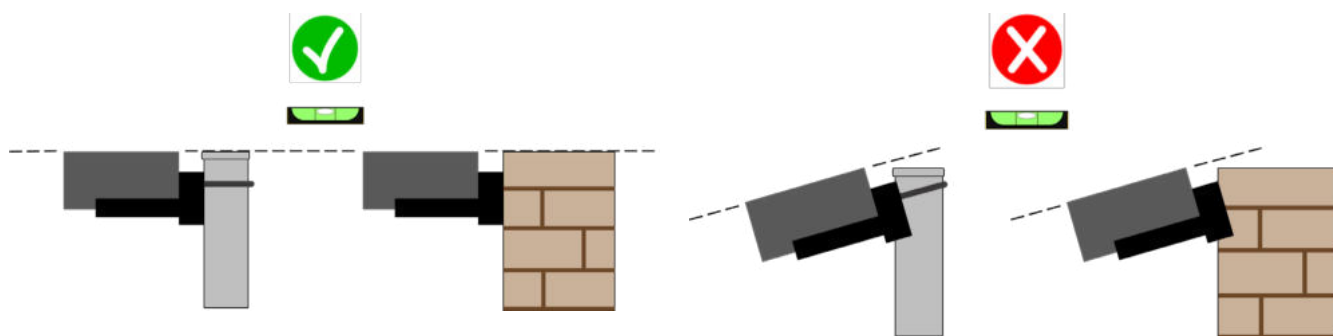
**WARNING:**

The surface or pole on which the satellite reference station is mounted must be stable and not move, sway or rotate, e.g. under strong wind or adverse weather conditions. The movement of the satellite reference station affects the operating accuracy of the robot lawn mower.

**WARNING:**

When installing the satellite reference station, proceed with caution. There is a risk of falling from considerable heights or of falling objects.

**WARNING:**

If the satellite reference station is moved, the virtual boundaries, transfer routes and areas to be avoided must be reconfigured through the APP.

**WARNING:**

Make sure that the satellite reference station is installed in a perfectly horizontal position.

4.5.3. RECHARGE THE ROBOT LAWN MOWER AFTER INSTALLATION

Please recharge the robot lawn mower before proceeding with the programming of virtual boundaries.

Requirements and obligations:

- charging base.

Procedure:

1. Recharge the robot lawn mower (See Par 5.5).

NOTE: When charged for the first time, the batteries must remain connected for at least 2 hours.

4.6. PROGRAMMING VIRTUAL PERIMETERS, TRANSITION ROUTES AND AREAS TO BE AVOIDED

The programming of the virtual perimeters, transition routes and areas to be avoided is performed using the respective “STIGA.GO APP” wizards. The procedure requires you to guide the robot lawn mower manually by walking alongside it according to the general instructions provided in Chap. 4.4.

Requirements and obligations:

- Android or iOS mobile device connected to the internet (not included).

Procedure:

1. Download the "STIGA GO" APP from Google Play Store for Android devices or from the App Store for iOS devices.
2. Follow the APP set-up wizard (for more information refer to par. APP).

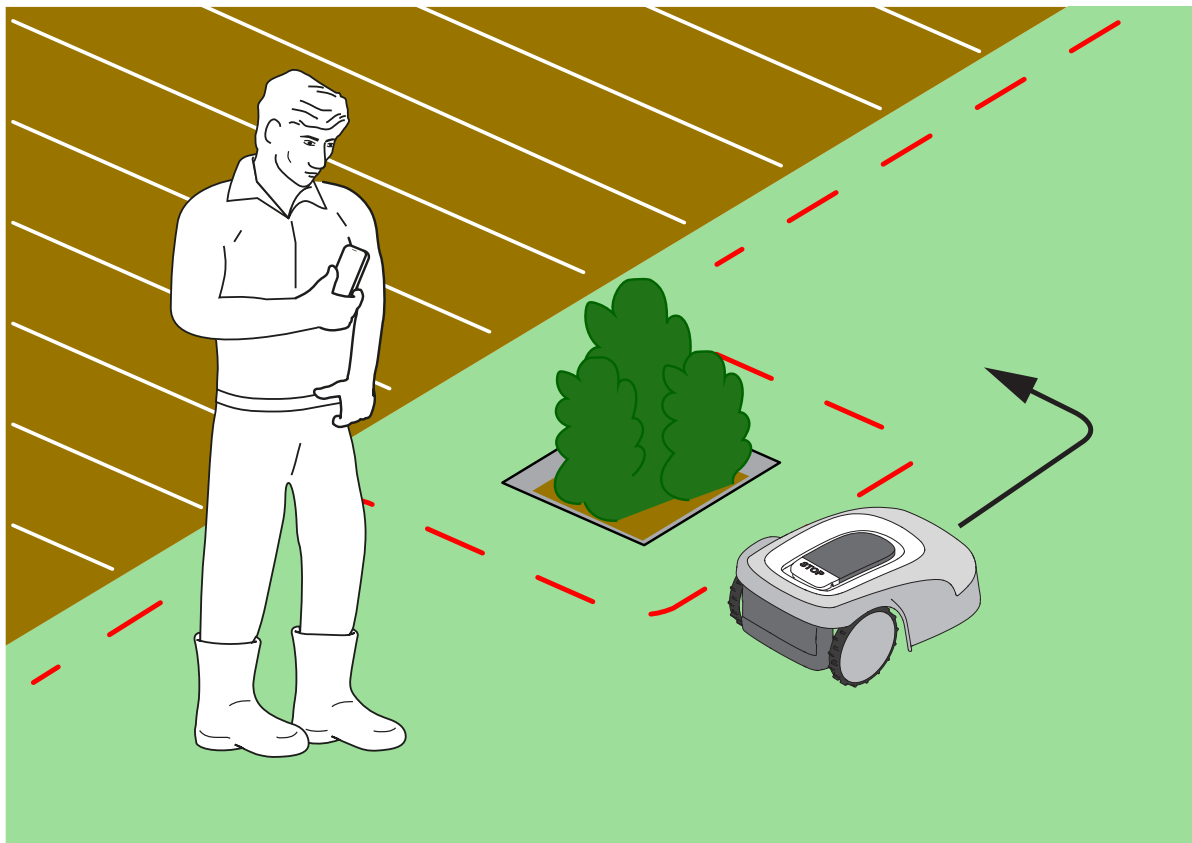

CAUTION:

The operating area or routes used by the machine while operating must be set up away from public areas to avoid damage to persons, property or vehicle accidents.



CAUTION:

For your own safety and to prevent damage to persons, animals or things, the operator must already be acquainted with the area in which the robot lawn mower is manually guided. When guiding the robot, walk carefully to avoid tripping.

4.7. PRODUCT FEATURES AND SETTINGS

The automatic operation of the robot lawn mower requires a series of settings that can be made via mobile device (smart phone) iOS or Android with the “STIGA GO” App installed.

The iOS app is downloadable from the iOS App Store. The Android app is downloadable from the Google Play Store.

TABLE OF CONTENTS

4.7.1. PRELOGIN	39
4.7.2. SIGN UP	39
4.7.3. DEVICE PAIRING	39
4.7.4. REMOTE CONNECTIVITY AND SIM CARD ACTIVATION.....	40
4.7.5. GARAGE AND DEVICE PAGE.....	40
4.7.6. CONFIGURATION OF THE CHARGING BASE.....	41
4.7.7. CALIBRATION OF THE CHARGING BASE	41
4.7.8. INITIALIZATION OF THE ROBOT LAWN MOWER	41
4.7.9. PROGRAMMING VIRTUAL PERIMETERS, TRANSITION ROUTES AND AREAS TO BE AVOIDED	42
4.7.10. PROGRAMMING THE RETURN ROUTE TO THE CHARGING BASE.....	43
4.7.11. GARDEN MAP.....	44
4.7.12. SPOT CUT / SCHEDULED.....	44
4.7.13. SCHEDULING MOWING SESSIONS	44
4.7.14. DATA PACKAGE MANAGEMENT	45
4.7.15. INTEGRATION WITH VOICE ASSISTANTS (AMAZON ALEXA, GOOGLE HOME).....	45
4.7.16. APP LOCK.....	45
4.7.17. SETTING THE DESIRED BROWSING MODE.....	45
4.7.18. BORDER CUT	46
4.7.19. RAIN SENSOR	46
4.7.20. FIRMWARE UPDATE	46
4.7.21. PROFILE / USER MANAGEMENT / CHOICE OF PREFERRED DEALER / MESSAGING	46
4.7.22. ANTI-THEFT ALARM	46
4.7.23. CHANGING OR DELETING VIRTUAL PERIMETERS, TRANSITION ROUTES AND AREAS TO BE AVOIDED.....	47
4.7.24. SETTING GARDEN AREA MOWING PRIORITIES.....	47
4.7.25. TEMPORARY NO-CUT ZONE.....	47
4.7.26. STAY AWAY	48
4.7.27. OBSTACLE NOTIFICATION.....	48
4.7.28. PROCEDURES FOR MOWING LARGE OPEN AREAS.....	49

4.7.1. PRELOGIN

When accessing the app for the first time users can:

- Access the information pages regarding STIGA retailers and products.
- Complete the first time user sign-up.
- Complete the Log in for already registered users.

4.7.2. SIGN UP

The “Sign Up” section allows users to register and grants them access to all app functions.

The user can log in through their Google, Facebook and Apple accounts, or create a new account by filling in the required fields .

The registration procedure requires an email verification.

4.7.3. DEVICE PAIRING

The "Device Pairing" section allows users to pair their mobile device with the robot lawn mower, the satellite tracking station and to configure the charging base via a Bluetooth® connection.

To add a new STIGA product, press the "add" (+) button and follow the set-up wizard.

To complete the pairing procedure, the robot lawn mower and the satellite reference station must be less than 8 metres away from the mobile device.

If the charging base is installed separately from the satellite reference station, it can be configured at a later date.

Once the pairing is complete, the product's main page is displayed, from which it is possible to access all available menus.

NOTE: If the charging base has been successfully paired, the indicator light on the charging base will lit up with a steady light whenever the robot lawn mower is outside the charging base. If pairing has not been completed, the indicator light flashes.

NOTE: After all devices have been paired, it is necessary to perform the "calibration of the charging base" before using the product (see par. 4.7.5).

NOTE: if the robot lawn mower is not detected by the mobile device, make sure it is not paired with another device (See Par. 5.3.6).

4.7.4. REMOTE CONNECTIVITY AND SIM CARD ACTIVATION

The robot lawn mower is equipped with a 3G/4G connectivity module with SIM card that allows connection to the STIGA cloud and remote control of the robot lawn mower. After linking the device with the user account, the SIM card must be activated.

Procedure:

Follow the APP wizard guided procedure.

NOTE: the SIM card contained in the product is proprietary. The product is only able to connect to the STIGA cloud via the supplied SIM card. Do not use other SIM cards.

4.7.5. GARAGE AND DEVICE PAGE

The "Garage" section displays all Stiga products associated with the user profile.

The paired items are displayed by scrolling left or right through the different screens.

For each of the items displayed, it is possible to access a range of options allowing the user to:

- rename or delete the device from the user account;
- access product information and manuals;
- check the mobile network connectivity status and GNSS signal status of the robot lawn mower and reference station;
- update firmware.

From the "Garage" section, you can access the "Product Page" of each associated item.

The robot lawn mower product page is divided into three sections:

- Robot.
- Settings.
- My garden.

It is possible to browse all sections by scrolling left or right through the different screens.

The "Robot" section allows users to:

- Check the robot lawn mower status (battery level, operating status, selected cutting mode).
- Start and stop the robot lawn mower.
- Force the robot lawn mower to return to the charging base.
- Start the robot mower to work in an area that cannot be reached independently.
- Check remaining connectivity hours and renew the data package.

The "Settings" section allows users to:

- Select either "Spot Cut " or "Scheduled" cutting mode.
- Set-up or change the work programme.
- Set-up or change the cutting height.
- Calibrate the positioning of the robot lawn mower in the charging base.
- Start the hibernation procedure for winter storage.
- Activate and select the rain sensor sensitivity.
- Activate the anti-theft function.
- Activate additional functions.

The "My Garden" section allows users to:

- Record virtual boundaries, transfer routes and areas to be avoided using the app wizard.
- Display the garden map with recorded items and the robot lawn mower's real-time position.
- Set the desired cutting direction.
- Start the robot lawn mower to work in a specific area of the garden.

4.7.6. CONFIGURATION OF THE CHARGING BASE

Before using the robot lawn mower, the charging base must be configured, (see par. 4.7.3)

4.7.7. CALIBRATION OF THE CHARGING BASE

Immediately after completing the charging base set-up, it is mandatory and required by the app to calibrate the return to base position.

The calibration allows the robot lawn mower to determine the correct alignment to the charging contacts, using the reading of the radio signal emitted by the antenna located underneath the base of the charging base.

Procedure:

1. Place the robot lawn mower on the charging base and connect it to the charging contacts.
2. If necessary, lift the robot lawn mower slightly by the rear handle and align it with the charging base to make sure it is perfectly aligned with it.
3. Check on the robot lawn mower keypad whether the 'ALARM' light icon is switched off, if not, reset the alarms before proceeding (see section 5.3.7).
4. Close the cover.
5. Start the calibration following the App Calibration Wizard.
6. Wait until a calibration confirmation message appears.

NOTE: If the procedure is not completed within 5 minutes after connecting the robot lawn mower to the charging contacts, the calibration is cancelled. It is necessary to disconnect the robot from the charging contacts and repeat the procedure from step 1.

4.7.8. INITIALIZATION OF THE ROBOT LAWN MOWER

The initialization of the robot lawn mower is mandatory and required by the app:

- When starting the product for the first time.
- When the robot lawn mower is switched on or restarted.
- When the robot lawn mower is moved manually.

First-time product start-up procedure

1. Position the robot lawn mower so that it will be able to move forward at least 3 m without encountering any obstacles.
2. Start the initialization as requested by the app and wait for the completion of the procedure. The robot lawn mower moves forward by taking three steps of approximately 1 m.

How to proceed when starting or moving the robot lawn mower manually:

1. Place the robot lawn mower inside a programmed area in a position that will allow it to move forward at least 3 m while remaining within the virtual boundary without encountering obstacles.
2. Start the initialization as requested by the app and wait for the completion of the procedure. The robot lawn mower will move forward by taking three steps of approximately 1 m.

4.7.9. PROGRAMMING VIRTUAL PERIMETERS, TRANSITION ROUTES AND AREAS TO BE AVOIDED

Before proceeding with the programming, make sure the following steps have been completed: device pairing (par. 4.7.3), configuration of the charging base (par. 4.7.5), calibration of the charging base (par. 4.7.6), initialization of the robot lawn mower (par. 4.7.7).

The programming of the virtual perimeters of the various Zones and Closed Areas, Transition Routes and Areas to be Avoided is performed using the respective STIGA.GO App wizard. The procedures require to manually guide the robot lawn mower, walking beside it.

The robot can be driven in two modes:

- Via Virtual Joystick in app.
- By means of the accessory Trolley cod: 1127-0021-01.

Following are the most relevant steps:

1. Follow the robot start-up procedure in APP, choose between the joystick and Trolley options.
2. Guide the robot lawn mower with the virtual Joystick or Trolley to the point where you want to start programming.
3. Start recording boundaries or virtual routes by pressing the designated button.
4. Guide the robot lawn mower with the virtual Joystick or Trolley around the perimeter or route to be programmed. The starting and ending points of the virtual perimeter must coincide. It is also possible to record the perimeter or virtual routes via the point-to-point method. In this case, the robot records the perimeter or route as a sequence of straight lines between the points selected by the user.



CAUTION:

Comply with the minimum distances from obstacles and the instructions in Par. 4.4

5. Confirm the recording.

NOTE: The maximum number of virtual cutting zones and zones to be avoided that can be recorded depends on the robot mower model.

NOTE: After programming the virtual boundaries, the robot lawn mower retraces the entire virtual boundary in order to check whether the programming was carried out correctly.

NOTE: In order to manage different areas of the garden differently, it is possible to programme several virtual zones.

NOTE: Virtual boundaries must be programmed before programming transfer routes and areas to be avoided.

NOTE: Do not move the robot lawn mower by hand, any manual handling of the robot lawn mower requires the initialisation procedure to be repeated.

NOTE: If the charging base has been installed along the edge of the area to be mowed, it is necessary to guide the robot over the floor of the charging base when programming the virtual boundaries.

NOTE: To ensure the correct operation of the robot lawn mower, avoid crossovers and/or overlapping in the virtual perimeter.

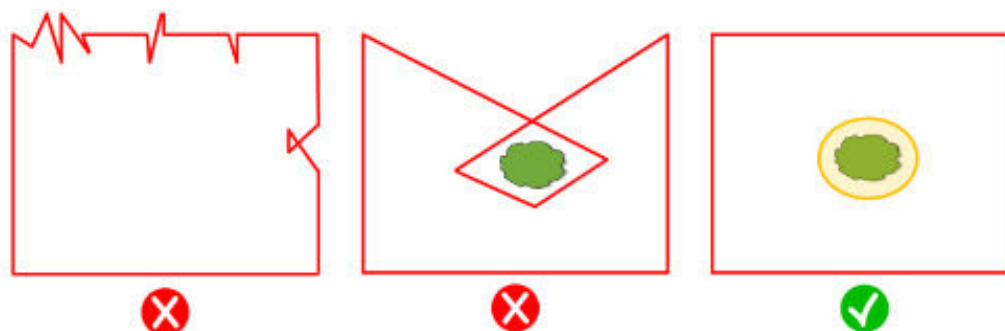

4.7.10. PROGRAMMING THE RETURN ROUTE TO THE CHARGING BASE

To facilitate the return of the robot lawn mower to the charging base, it is necessary to programme the return path following the following specifications:

- The return path must be at least 3 m long.
- The section leading back to the charging base must be at least 3 m long, straight and aligned with the centre of the charging base (it may coincide with the entire return path).
- The starting point of the return path must be within the virtual boundary at a distance of at least 1 metre from the perimeter in order for the robot lawn mower to reach it independently.
- The end point corresponds to the charging position of the robot lawn mower.

NOTE: Before programming the transfer path to the charging base, it is necessary to programme the virtual boundaries.

NOTE: Comply with the minimum distances from obstacles and the instructions in Par. 4.4

In some cases it is possible to activate a long reverse manoeuvre (Long Exit) via the app, in which case the robot mower performs a 2 m reverse manoeuvre before turning 180°. See Par. 4.3.2 for more details.

Procedure:

1. Make sure the virtual boundary of the area where the transfer path begins has been programmed, if required perform an initialisation.
2. From the "My Garden" menu, select the programmed zone from which the return route to the charging base should start, select the creation of a new connection and choose "Charging Base".
3. Guide the robot lawn mower with the joystick to the point where you want to start programming.
4. Start recording the return journey to the charging base by pressing the specific button.
5. Guide the robot lawn mower manually using the joystick along the route to be programmed until the robot connects with the charging contacts.
6. Confirm the recording.

NOTE: Do not move the robot lawn mower by hand, any manual handling of the robot lawn mower requires the initialisation procedure to be repeated.

NOTE: The charging base can also be installed outside the working area. In this case, the robot will use the entire re-entry path to return to the charging base and to reach the work area while running.

NOTE: At the end of programming the return to base route, the robot lawn mower retraces the entire route in order to check whether the programming was carried out correctly.

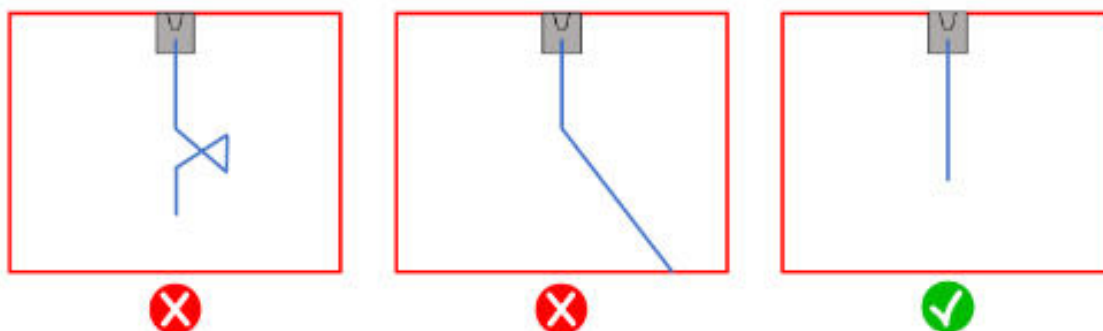

4.7.11. GARDEN MAP

From the "My Garden" section, users can access the garden map and view:

- Virtual boundaries.
- Areas to be avoided.
- Transfer routes.
- The real-time position of the robot lawn mower.
- The location of the charging base and its return path.

4.7.12. SPOT CUT / SCHEDULED

The "Spot Cut / Scheduled" selector in the settings menu allows the user to activate or deactivate the scheduled work programme.

The number of weekly hours to schedule are suggested by the app according to the size of the garden.

- If set to "Scheduled" the robot lawn mower works according to the scheduled work programme.
- If set to "Spot Cut" the robot lawn mower works by performing a single work cycle.

NOTE: When the robot lawn mower ends a complete garden coverage cycle, it returns to the charging base and remains there until the next pre-set start time.

NOTE: When the robot lawn mower finishes a single zone coverage cycle, it continues directly to the next cutting zone.

4.7.13. SCHEDULING MOWING SESSIONS

The "Cutting Sessions" section allows the user to schedule the robot lawn mower's working hours and days. The number of weekly hours to schedule are suggested by the app according to the size of the garden.

Procedure:

1. From the "Settings" menu, select "Cutting Sessions" and choose a day of the week on which to set the desired work sessions.
2. The user has the option of applying the same working hours to several days of the week.
3. The working time will be displayed within the day on which it is scheduled. By pressing on each working time it is possible to copy or delete it.

4.7.14. DATA PACKAGE MANAGEMENT

The subscription fee for SIM card data traffic is included for the entire useful life of the product and does not entail any additional costs.

4.7.15. INTEGRATION WITH VOICE ASSISTANTS (DEPENDING ON THE MODEL) (AMAZON ALEXA, GOOGLE HOME)

The integration with a voice assistant makes it possible to interact with the robot lawn mower according to the options available on the app, for example:

- Starting a work session.
- Stopping the robot lawn mower while mowing the lawn and resuming work.
- Force the robot lawn mower to return to its charging base.
- Ask about the next scheduled start time.
- Ask about the robot lawn mower's status.
- Ask about the remaining hours of connectivity.

NOTE: integration of the robot lawn mower with a voice assistant is not done via the Stiga.GO app, but must be set up via the voice assistant app itself.

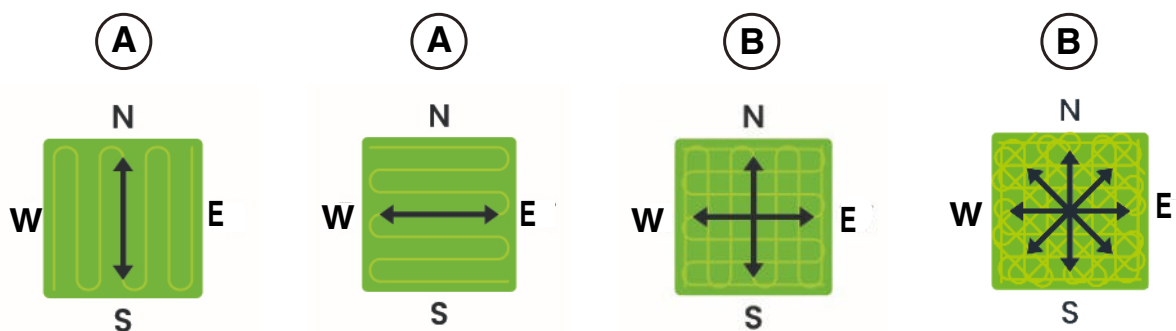

4.7.16. APP LOCK

In order to prevent the robot lawn mower from being used by children or unauthorised persons, the keypad can be locked. This will allow the robot lawn mower to be controlled solely via the App.

Procedure:

1. Activate or deactivate the Keypad/App Lock function from the app's 'settings' menu.

NOTE: When the function is active, the keypad lock remains active even if the robot lawn mower is switched off.

4.7.17. SETTING THE DESIRED NAVIGATION MODE

This function allows the user to set the navigation mode used by the robot lawn mower to move around the garden while mowing the lawn.

It is possible to select different mowing directions (A), or a combination of them (B). It is also possible to fine-tune the selected mowing direction to align it with any structures or shapes in the garden. Adjustment can be performed in a range of -90° to $+90^\circ$, with an accuracy of 0.1° .

The change of navigation mode made by the user in an area where mowing has started but not yet completed, becomes effective after the mowing of the relevant area has been completed.

Procedure:

1. Select the desired navigation mode from the app's "settings" menu.
2. If necessary, adjust the mowing direction with the '+' and '-' buttons until the desired setting is achieved.

4.7.18. BORDER CUT

The "Border Cut" section if activated, allows the mowing of the garden border or no-cut zones. The border cut is carried out by the robot lawn mower after having completed the mowing of the scheduled area.

Procedure:

1. Activate the "border cut" function from the app's "settings" menu. It is possible to activate the function separately for each scheduled virtual or no-cut zone.

4.7.19. RAIN SENSOR

The "Rain sensor" function allows to enable or disable the rain sensor on the robot lawn mower. The rain sensor can be set to three different sensitivity levels. A higher sensitivity corresponds to a prolonged permanence in the base in case of rain.

Low sensitivity: 4 hours, Medium sensitivity: 8 hours, High sensitivity: 12 hours,

Procedure:

1. Activate the function from the app's "settings" menu.

4.7.20. FIRMWARE UPDATE

Firmware updates for the product, if available, shall be displayed on the product display page under "Garage".

Available updates are performed in sequential order: robot lawn mower, reference station, charging base. During the update, the phone must be kept close to the device being updated. The update of each device may take between 10 to 20 minutes.

The user can also access the menu on the product display page under "Garage" to check for updates and force a firmware update.

4.7.21. PROFILE / USER MANAGEMENT / CHOICE OF PREFERRED DEALER / MESSAGING

From the "Profile" section, users can edit their account details and change their password.

The main user who registered for the first time can invite and manage other robot lawn mower users.

The invited user must download the App on their mobile device and must register.

The "Dealer" section allows to choose the reference service centre.

The "Messages" section allows to view messages \ information.

4.7.22. ANTI-THEFT DEVICE (DEPENDING ON THE MODEL)

This function allows the user to receive a warning notification when the robot lawn mower is distant from the work area. If the function is active, the robot lawn mower will continuously monitor its distance from the virtual perimeter. When the robot lawn mower is moved away from the virtual perimeter for more than 100 metres:

- The robot sends a notification to the user's mobile device through the Stiga.GO App.
- On the app, it is possible to view the actual position of the robot and track its movements.
- It is not possible to start the robot lawn mower to work as long as it is outside its virtual perimeter.

NOTE: The Anti-Theft function remains active even if the robot lawn mower is switched off. In this case, a theft notification and the location of the robot lawn mower are sent once the robot is switched on.

Procedure:

1. Activate the function from the app's "settings" menu. Ensure that Stiga.GO App notifications have been activated on the mobile device.
2. Activate the 'Anti-theft' notification in the sidebar of the Stiga.GO App.

4.7.23. CHANGING OR DELETING VIRTUAL PERIMETERS, TRANSITION ROUTES AND AREAS TO BE AVOIDED

The virtual perimeter of the different zones can be changed in two ways:

- Deletion: the item is entirely deleted and new programming is required.
- Change: it is possible to change only a part of the element without deleting it entirely.

Should it be necessary to change transition routes or areas to be avoided, these must be deleted and then re-programmed.

Procedure:

1. To delete a map item, select it from the App's 'settings' menu and press the 'delete' button.
2. To change the virtual perimeter, select the desired virtual zone from the App's 'Settings' menu and press the 'Edit' button. Then follow the App wizard.

4.7.24. SETTING GARDEN AREA MOWING PRIORITIES

The different virtual areas of the garden are mowed in the order in which they are programmed.

It is possible to change the mowing priority of individual zones to vary the order in which they are mowed.

Procedure:

1. Select the desired virtual mowing zone from the App's 'Settings' menu and drag it to the desired position in the zone list.

NOTE: For each area of the garden, the percentage of mowing actually completed is also indicated, thus identifying the areas that have already been completely mowed and the progression of the area that is currently being mowed.

4.7.25. TEMPORARY NO-CUT ZONE (DEPENDING ON MODEL)

The 'Temporary No-Cut Zone' function allows a part of the garden to be temporarily excluded from the mowing area. The selectable area must be a portion of the perimeter between two points A and B selected by the user, and the straight segment connecting them. The selected area cannot intersect transition routes.

The robot lawn mower will not enter the excluded zone until the set time has elapsed, but will continue working in the other parts of the garden.

Procedure:

1. Activate the function from the App's "settings" menu.
2. Follow the App wizard to select the part of the garden to be excluded and set the desired duration.

NOTE: The maximum number of avoidance zones that can be registered depends on the model of the robot mower.

4.7.26. STAY AWAY (DEPENDING ON THE MODEL)

The 'Stay Away' function allows a part of the garden to be temporarily excluded from the mowing area. The selectable area is a circle of radius chosen by the user and has the GPS position of the mobile device or a point selected on the virtual map as its centre. The selected area cannot intersect transition routes. The robot lawn mower will not enter the excluded zone until the set time has elapsed, but will continue working in the other parts of the garden.

Procedure:

1. Activate the function from the App's "settings" menu.
2. Follow the App wizard to select the part of the garden to be excluded and set the desired duration.

NOTE: If the GPS position of the mobile device is used to set the centre of the circle, the position of this point, and therefore of the non-cut area, depends on the accuracy of the GPS signal received from the mobile device, which is generally +/- 5 metres.

NOTE: The maximum number of avoidance zones that can be registered depends on the model of the robot mower.

4.7.27. OBSTACLE NOTIFICATION (DEPENDING ON THE MODEL)

The 'Obstacle Notification' function allows you to receive a push notification if the robot lawn mower detects obstacles when mowing.

If the function is active and the robot lawn mower hits an obstacle a certain number of times, the position of that obstacle is memorised. When the robot lawn mower returns to the charging base, it sends a push notification to the user's mobile device containing all obstacles detected during the mowing session.

The user can:

- Ignore the presence of such obstacles and let the robot lawn mower bump into them.
- Physically remove obstacles from the work area.
- Automatically confine obstacles by means of a circular virtual no-cut zone. In this case, the user selects the obstacles to be virtually confined from the list of detected obstacles, choosing the radius of the no-cut zone circle to be created.
- Confining obstacles by means of a manually recorded virtual no-cut zone. This option is recommended in the case of large or non-circular shaped obstacles.

Procedure:

1. Activate the function from the App's "settings" menu.
2. In case of obstacles, a push notification will be sent to the mobile device.
3. Open push notification and view obstacles found.
4. If you wish to confine these obstacles with a virtual no-cut zone, follow the App wizard.

NOTE: The maximum number of avoidance zones that can be registered depends on the model of the robot mower.

4.7.28. CUTTING MODE FOR LARGE OPEN AREAS (WIDE AREA MODE) (DEPENDING ON THE MODEL)

The 'large open areas' function allows the cutting result to be optimised for large, regularly shaped and uncomplicated areas, such as sports fields.

If the function is active, the mowing robot's movement speed is increased, and the cutting path planning is optimised for this type of application.

Procedure:

1. Activate the function from the App's "settings" menu.

5. OPERATION

Requirements and obligations:

- Installation of the charging base and satellite reference station (See Chapter 4.5)
- Initial grass height in the robot lawn mower operating range: 20-60 mm
- Battery charged (See Par. 5.5)
- Programming virtual boundaries, transition routes and areas to be avoided (See par. 5.6)
- Cutting height suitably adjusted (See Par. 5.6)

5.1. CHECK OF SAFETY DEVICES FOR STARTING THE ROBOT LAWN MOWER

Requirements and obligations:

- Safety key.

Procedure:

1. Check that the floating cover (A) is fitted correctly. If the cover is missing the robot lawn mower doesn't work.
2. Check that the safety key (E) is inserted. If it is not inserted the robot lawn mower doesn't start.
3. Make sure that the stop button "STOP" (B) is not switched on. If pressed, it stops the robot lawn mower and opens the protective cover (C) of the control console (D).
4. Check that the robot lawn mower is positioned on the ground correctly. In the event of excessive tilting ($\geq 45\%$ or $>50\%$) and lifting, the tilt sensors (inclinometer) will stop the robot lawn mower.

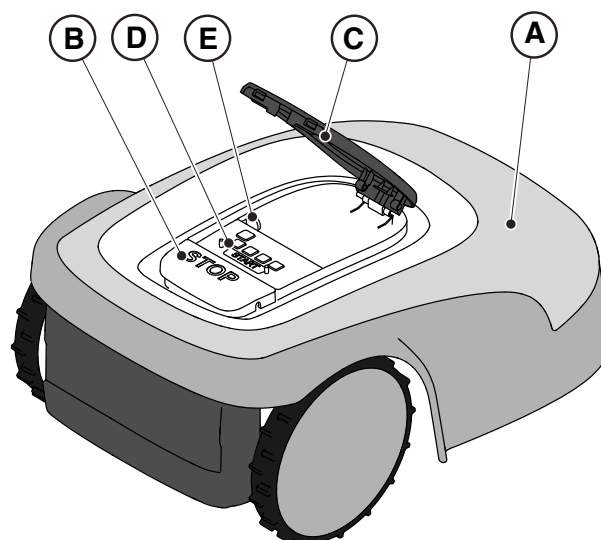

5.2. MANUAL FUNCTIONING OF THE ROBOT LAWN MOWER

The robot lawn mower can be used without performing the programming procedure described in Par. 4.7. In this mode the robot lawn mower carries out a work cycle, returns to the charging base and remains there until the next manual start.

In order to use the machine in this mode, it is still however necessary to programme the virtual perimeters, transition routes and areas to be avoided. (See par. 4.6).

Procedure:

1. Put the robot on the charging base in the installation perimeter, or in any case inside the installation perimeter.
2. Press the **"STOP"** button (A) to open the cover (B) and access the control console (C).
3. Press the **"SELECT MODE"** button (F) until only the icon (L) flashes.
4. Press the **"CONFIRM"** push button (G). The icon (L) lights up with a steady light to confirm the operation.
5. Close the cover (B).
6. The robot lawn mower will start operating.

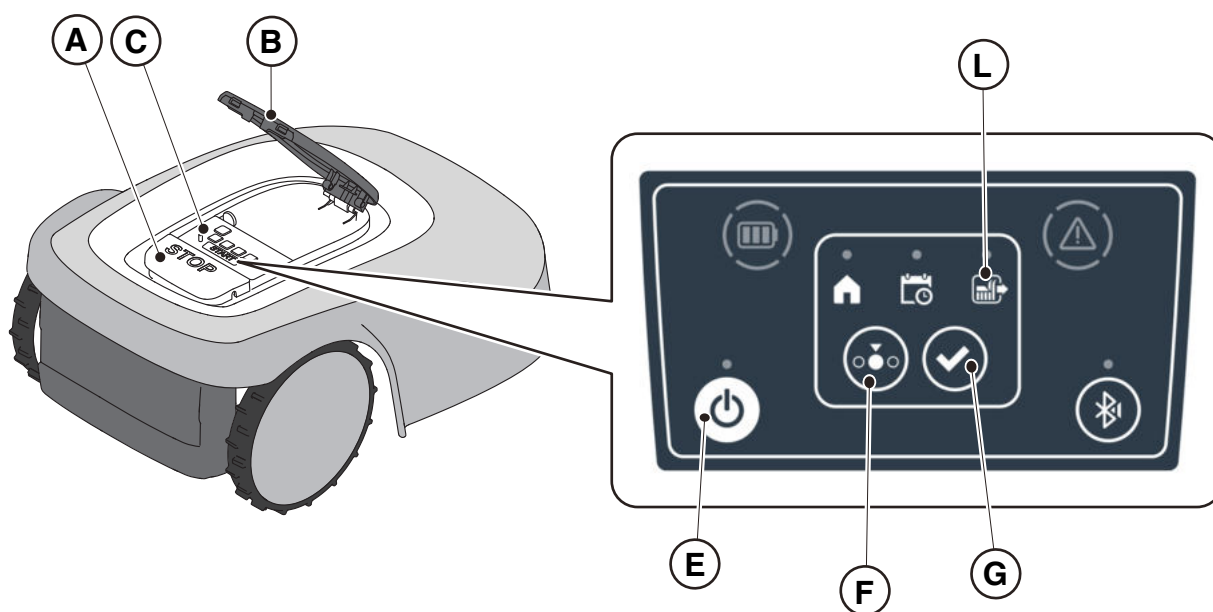

NOTE: this mode may not guarantee adequate coverage of the garden, both in terms of time required and in terms of uniformity of the cutting result, especially if the garden has an irregular shape. To achieve the maximum efficiency of the robot lawn mower, it is recommended to carry out programming (See par. 4.7).

NOTE: If after pressing the **"CONFIRM"** button (G), the **"SELECT MODE"** button (F) is pressed, the icons for the selected functions will start flashing again, requesting confirmation of the newly selected function. Press the **"CONFIRM"** button (G). The icons will once again light up with a steady glow.

NOTE: if the cover (B) is opened, either during work or with the robot in the base, the icons relating to the selected functions will flash, to indicate that it is necessary to confirm the operation before closing the cover again. If the cover is closed without pressing the **"CONFIRM"** button (G), the robot will not perform any operation until a new command is given by the user.

5.3. DESCRIPTION OF THE CONTROLS ON THE ROBOT LAWN MOWER

List of controls, indicators and their function:

- The “**STOP**” button (A): is used to safely stop the robot mower.
- The “**SAFETY KEY**” (D): is used for the safety shut-down of the robot lawn mower.
- The “**ON/OFF**” button (E): is used to turn the robot lawn mower on and off and resetting the alarms..
- The “**MODE SELECTION**” button (F): is used to select the operating mode of the robot lawn mower and to force it to return to the charging base.
- The “**CONFIRM**” button (G): is used to confirm the operating mode set.
- The “**SCHEDULED PROGRAM**” light icon (I): is used to display the scheduled program settings.
- The “**SINGLE WORK CYCLE**” light icon (L): is used to display the single work cycle settings.
- The “**RETURN TO BASE**” light icon (H): is used to display the forced return-to-base setting of the robot lawn mower.
- “**BLUETOOTH®**” button (M): is used only by the service centre for diagnostic purposes.
- The “**ALARM**” light icon (N): is used to display the alarms status.
- The “**BATTERY**” light icon (O): is used to display the battery charging.

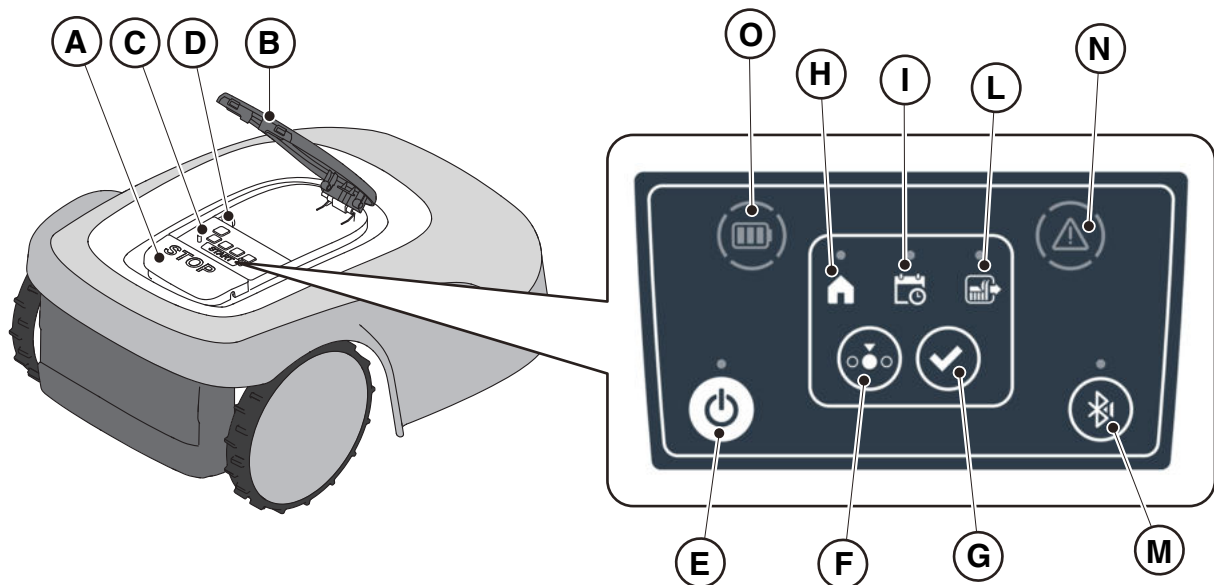

5.3.1. SAFE STOP - STOP BUTTON

The "STOP" button (A) is a control that stops the robot lawn mower in safety conditions, whatever its operating condition is.

Procedure:

1. Press the "STOP" button (A) while the robot lawn mower is moving or already still.
2. When the "STOP" button (A) is pressed, the robot lawn mower stops and the cover (B) opens, allowing access to the other robot controls.

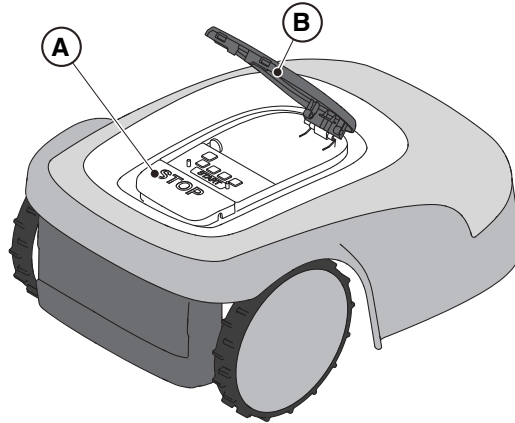

5.3.2. SAFE SHUTDOWN - SAFETY KEY

The safety key (D), by switching off, allows the robot lawn mower to be switched off safely.



OBLIGATION:

Always remove the safety key before each cleaning, transport and maintenance operation

Procedure:

1. Press the "STOP" button (A) to open the cover (B) and access the control panel (C).
2. Push the off button (E) for a few seconds and wait for the LED on the same button to go out.
3. Only disengage the safety key (D) after the LED (E) go out to switch off the robot lawn mower in safe conditions. Keep the key in a safe place.
4. After carrying out the maintenance operations, insert the safety key to be able to switch on the robot lawn mower.

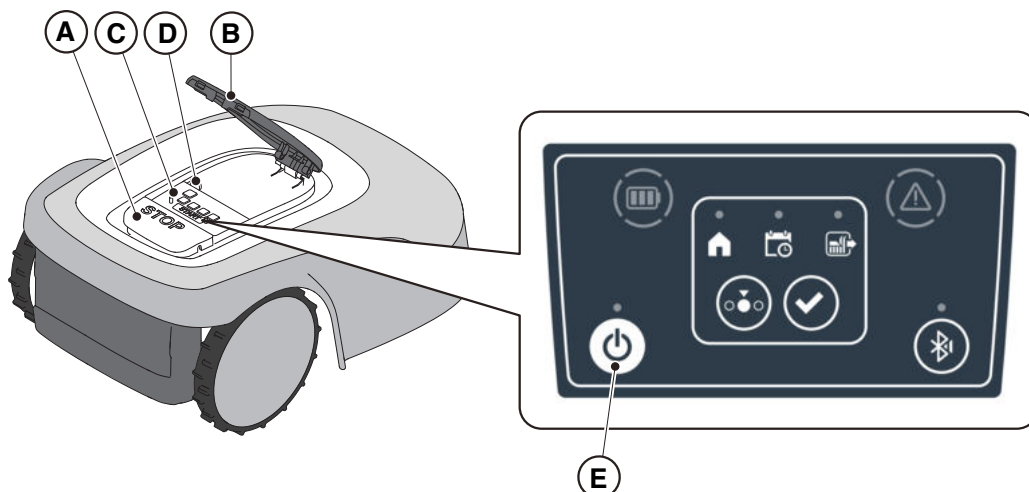

5.3.3. SWITCHING THE ROBT LAWN MOWER ON AND OFF - ON / OFF BUTTON

The "ON / OFF" button (E) allows to switch the robot lawn mower on and off manually.

Procedure:

1. Press the "STOP" button (A) to open the cover (B) and access the control panel (C).
2. Press the "ON/OFF" button (E) for 5 seconds to switch on the robot lawn mower or to switch it off.

NOTE: To switch on the robot lawn mower, the safety key (D) must be inserted.

NOTE: In case of active alarms, a double press of the "ON/OFF" button will reset the alarms.

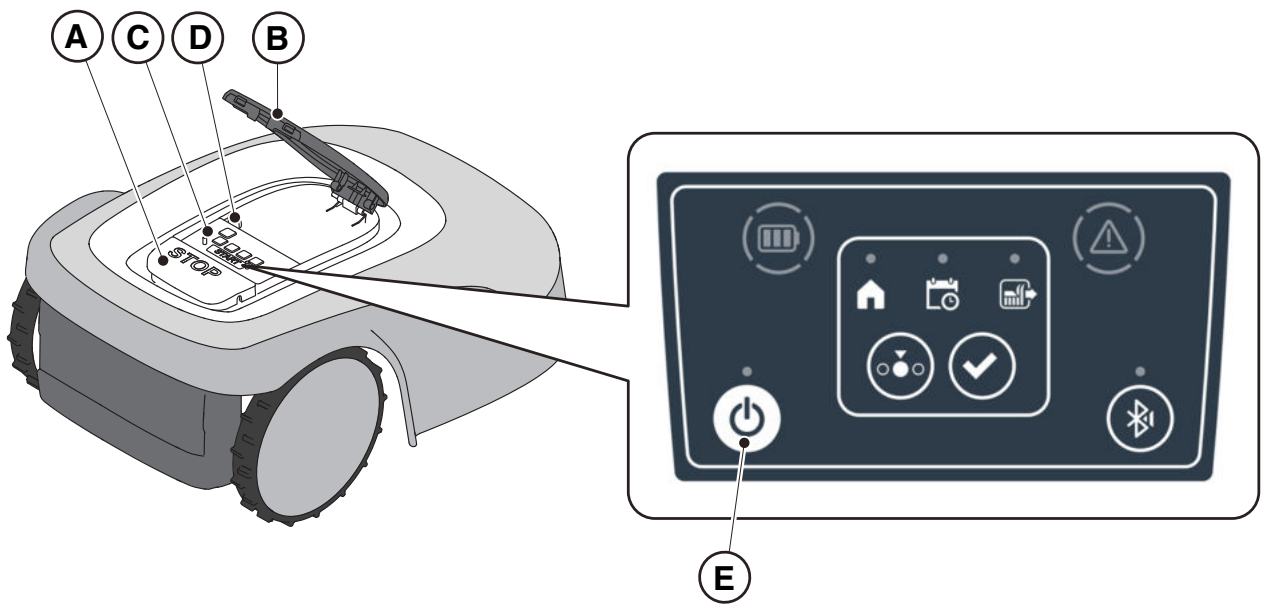

5.3.4. SCHEDULED PROGRAMME SELECTION / SINGLE WORK CYCLE / FORCED RETURN TO CHARGING BASE - MODE SELECTION BUTTON

The "**MODE SELECTION**" button is used to activate or deactivate the set work program via the App and to select the forced return to the charging base. The robot lawn mower operates according to the possible selections described below.

KEYBOARD SELECTIONS AND ROBOT OPERATION

SCHEDULED PROGRAM

The robot lawn mower operates according to the programming set via the app.



RETURN TO BASE + SCHEDULED PROGRAM

The robot lawn mower returns to the charging base. The robot lawn mower will resume working from the following set start time.

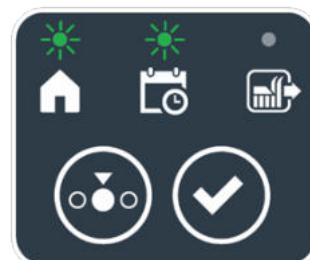

SINGLE WORK CYCLE + SCHEDULED PROGRAM

The robot lawn mower performs a single forced work cycle and returns to the charging base when finished. The robot lawn mower will resume working from the following set start time.

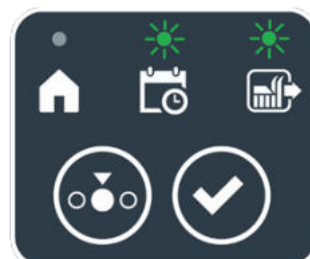

SINGLE WORK CYCLE

The robot lawn mower performs a single forced work cycle and returns to the charging base. The robot lawn mower stays in the base until the user intervenes manually.



RETURN TO BASE + SINGLE WORK CYCLE

The robot lawn mower returns to the charging base. The robot lawn mower stays in the base until the user intervenes manually.



Procedure:

1. Press the “**STOP**” button (A) to open the cover (B) and access the control console (C).
2. Press the “**MODE SELECT**” button (F) until the icons of the functions you wish to activate flash. The icons relating to the selected functions flash.
3. Press the “**CONFIRM**” push button (G). The icons of the selected functions light up steadily to confirm the action.
4. Close the cover (B).
5. The robot lawn mower will start working according to the set mode.

NOTE: If after pressing the “**CONFIRM**” button (G), the “**SELECT MODE**” button (F) is pressed, the icons for the selected functions will start flashing again, requesting to confirm the newly selected function. Press the “**CONFIRM**” button (G). The icons return to a steady light.

NOTE: If the cover (B) is opened, either during work or with the robot in the base, the icons relating to the selected functions will flash, to indicate that it is necessary to confirm the operation before closing the cover again. If the cover is closed without pressing the “**CONFIRM**” button (G), the robot will not perform any task until a new command is given by the user.

NOTE: If the robot battery is low, the battery icon flashes red to indicate that the selected action cannot be performed.

NOTE: The robot lawn mower starts only after closing the cover (B).

NOTE: The robot lawn mower goes to the charging base with the cutting device switched off.

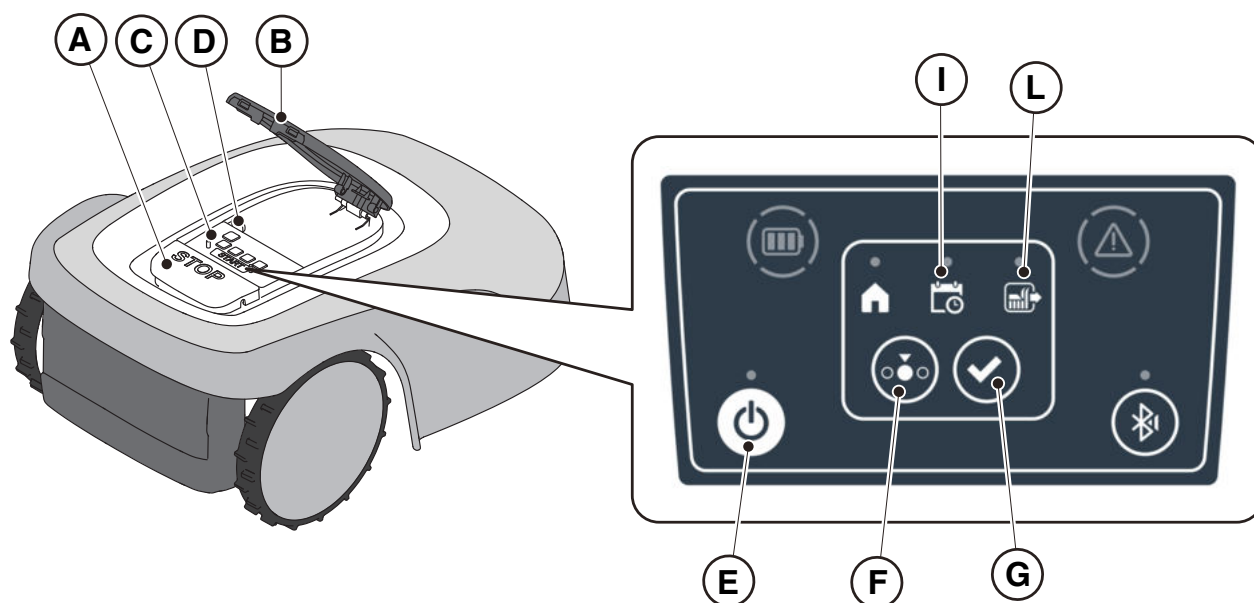

NOTE: If after pressing the “**CONFIRM**” button (G), the “**SELECT MODE**” button (F) is pressed, the icons for the selected functions will start flashing again, requesting confirmation of the newly selected function. Press the “**CONFIRM**” button (G). The icons will once again light up with a steady glow.

NOTE: if the cover (B) is opened, either during work or with the robot in the base, the icons relating to the selected functions will flash, to indicate that it is necessary to confirm the operation before closing the cover again. If the cover is closed without pressing the “**CONFIRM**” button (G), the robot will not perform any operation until a new command is given by the user.

5.3.5. BLUETOOTH® STATUS DISPLAY - BLUETOOTH® BUTTON

The robot lawn mower handles automatically the Bluetooth® connection with external mobile devices. The Bluetooth® connection is available at all times when the robot lawn mower is switched on. It is possible to connect only one mobile device at a time to the robot lawn mower via Bluetooth®. The robot lawn mower automatically disconnects from the device when the app is closed. The 'BLUETOOTH®' button (M) is used only by the service centre for diagnostic purposes.

NOTE: For pairing the device with the robot lawn mower via Bluetooth®, see Par. 4.7.3 “Pairing”.

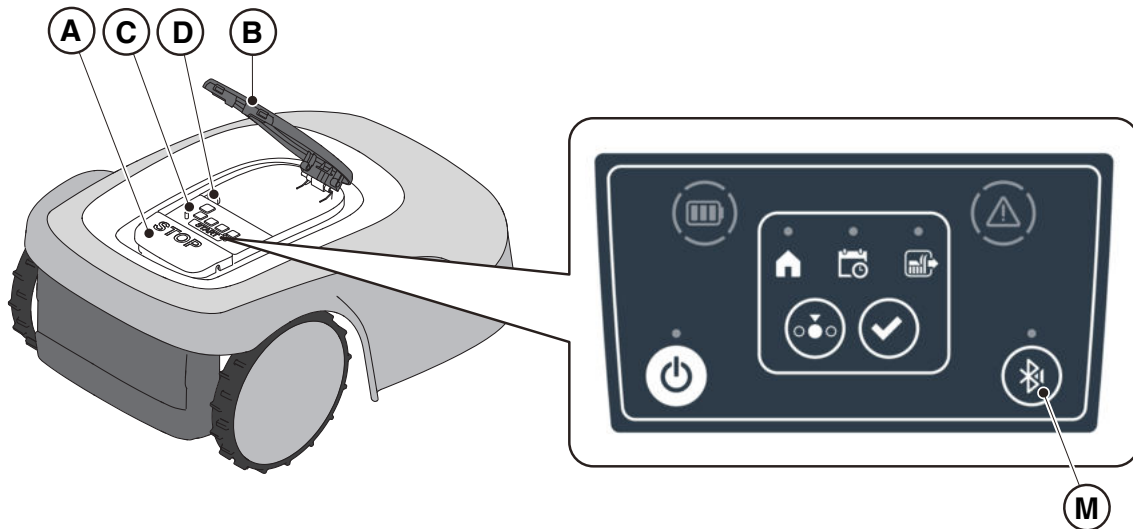

5.3.6. DISPLAY OF ALARM STATES-ALARM ICON

The “ALARM” light icon (N) indicates an operating anomaly.

Procedure:

1. Press the “STOP” button (A) to open the cover (B) and access the control panel (C).
2. Check the alarm status through the red light icon (N), which can be lit either steady or flashing.
3. After resolving the fault, press the "ON/OFF" button (E) twice in rapid succession to reset the alarm. The light icon (N) goes out, and the robot lawn mower can be restarted. If the icon (N) does not go off, turn off the robot lawn mower using the “ON/OFF” button (E), wait a few seconds and then switch the robot lawn mower on again using the "ON/OFF" button (E). If the problem persists, contact a service centre.

NOTE: Details about anomalies are viewable on the App.

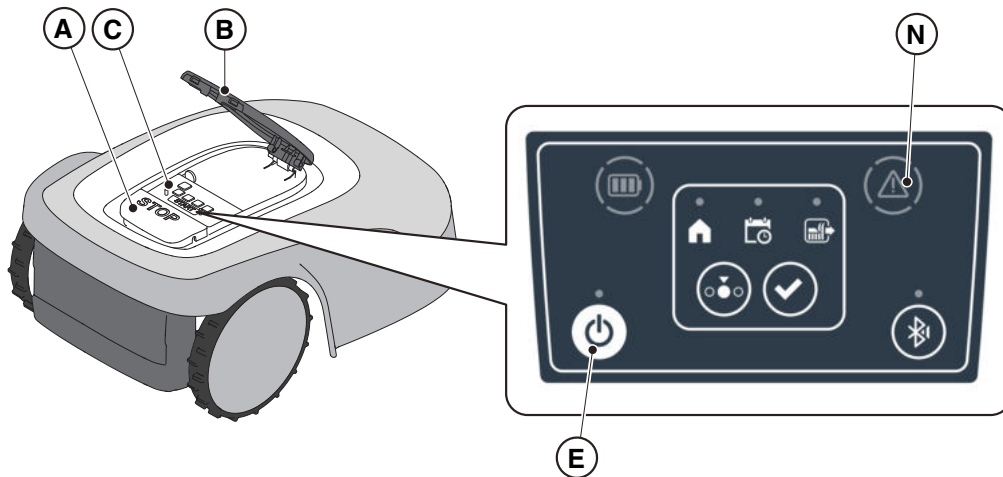

5.3.7. BATTERY CHARGE DISPLAY-BATTERY ICON

The “BATTERY” light icon (O) indicates the battery charge status.

Procedure:

1. Press the “STOP” button (A) to open the cover (B) and access the control panel (C).
2. Check the battery charging status through the light icon (O):
 - Blue icon: the battery is charged (charge level >40 %).
 - Red icon: the battery is charging (charge level 15-40 %).
 - Flashing red icon: the battery charge is low (charge level <15%).
3. If the robot lawn mower is charging, the light icon (O) flashes.

NOTE: if the battery icon (O) flashes rapidly red when a command is pressed, the operation cannot be carried out and it will be necessary to charge the battery manually (See Par. 5.5).

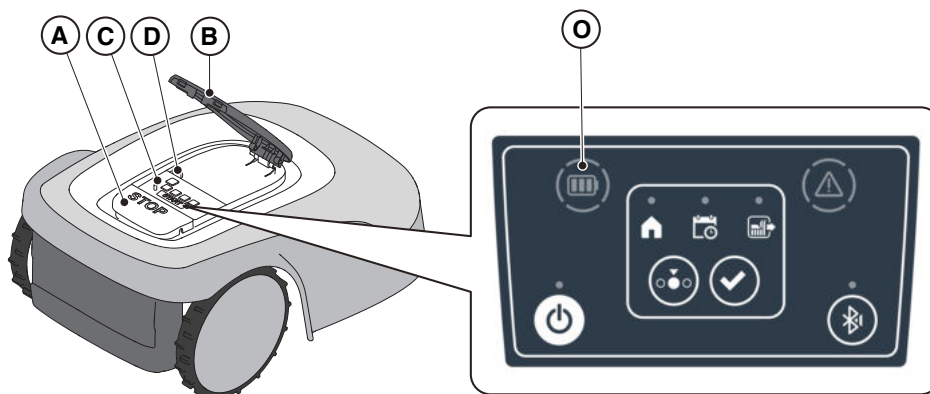

5.3.8. STARTING THE ROBOT LAWN MOWER

To start up the robot lawn mower, follow the procedure described in Par. 5.3.4 "SCHEDULED PROGRAM SELECTION / SINGLE WORK CYCLE / FORCED RETURN TO CHARGING BASE - MODE SELECTION BUTTON".

5.4. FUNCTIONING OF THE CHARGING BASE

The charging base is equipped with an indicator light (N) that lights up in the following manner:

- Warning light off: the charging base is powered off or the robot is on the base;
- Indicator light flashing slowly: the charging base is not set up correctly;
- Indicator light flashing rapidly: there is a fault in the charging base.
- Indicator light flashing rapidly twice or three times: the charging base has detected a short circuit on the charging contacts. (See Chap. 7).

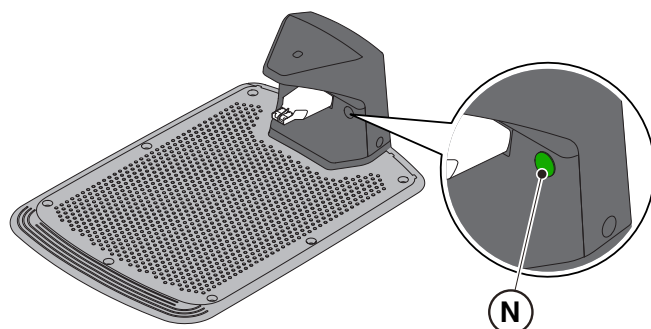

5.5. BATTERY CHARGING

The "BATTERY CHARGING" procedure allows to recharge the robot lawn mower manually.

Requirements and obligations:

- charging base connected to the mains.

Procedure:

1. Position the robot lawn mower on the charging base (R).
2. Slide the robot lawn mower onto the charging base, until the charging connector (S) is engaged.
3. Press the "STOP" button (A) to open the cover (B) and access the control panel (C).
4. Turn the robot lawn mower on with the "ON/OFF" button (E).
5. A few seconds later, the "BATTERY" icon (O) flashes blue to indicate that the robot lawn mower is charging.
6. Close the cover (B).
7. Leave the robot lawn mower to charge for at least the time shown in Par. 4.5.3.

NOTE: Charging the battery before winter storage should be carried out as shown in Par. 6.4.

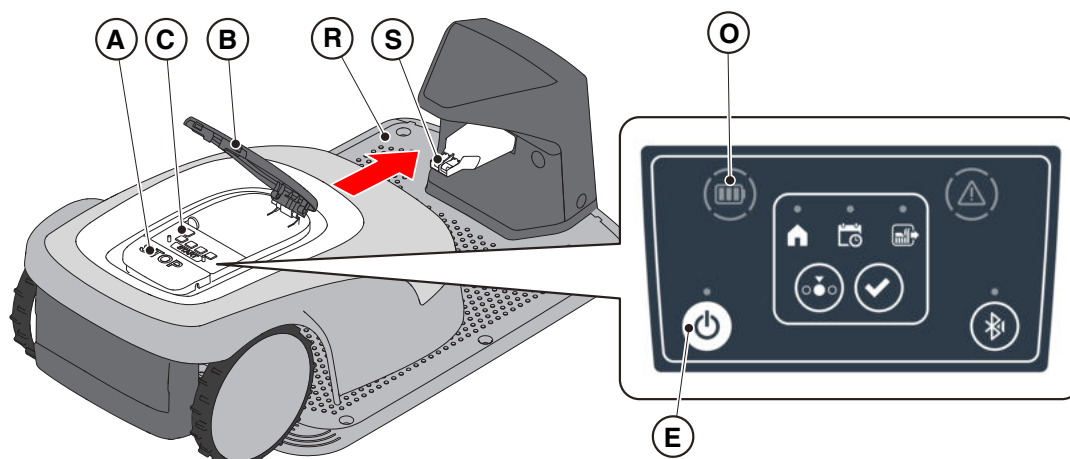

5.6. CUTTING HEIGHT ADJUSTMENT

The "CUTTING HEIGHT ADJUSTMENT " procedure describes how to adjust the height of the cutting blades.

- The length X of grass cut by the robot lawn mower must not exceed 10mm.
- The robot lawn mower's operating range is 20-60 mm (cutting height).
- The initial height of the grass Y must therefore be 70mm maximum.

At the first installation or at the beginning of the mowing season, if necessary, prepare the garden with a traditional lawn mower to bring the initial height of the grass to an appropriate value.

NOTE: if you want to cut the grass more than 10 mm, adjust the cutting height so that the cut grass part is 10mm. Lower the cutting height further only after the garden has been mowed evenly.

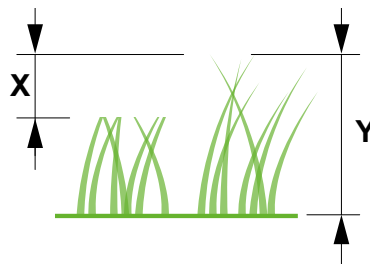

Procedure:

1. Follow APP wizard to adjust the cutting height.



CAUTION:

Do not touch the cutting means when adjusting the cutting height.



WARNING:

In order to ensure the proper functioning of the blade height adjustment system, make sure that no grass residue or dirt accumulates in the vicinity of the blades and the blade motor protection bellows.

NOTE: The blade height adjustment system requires an initial calibration and subsequent periodic calibrations, which are performed automatically. Calibration can also be performed manually using the dedicated menu in the App.

5.6.1. AUTOMATIC CUTTING HEIGHT ADJUSTMENT (IF AVAILABLE)

Thanks to the automatic cutting height adjustment, the height of the blades is automatically raised or lowered according to the effort measured by the blade motor. In the event of excessive effort, the robot lawn mower automatically raises the cutting height. In subsequent cutting cycles the cutting height is gradually lowered in order to reach the set value.

Procedure:

1. Activate the function through the App's "settings" section.

6. MAINTENANCE

6.1. SCHEDULED MAINTENANCE



CAUTION:
Only use original spare parts.



CAUTION:
Do not modify, tamper with, elude or eliminate the safety devices installed.

For a better operation and longer life, be sure to clean the product regularly and replace worn parts.

Perform the interventions following the frequency indicated in the table.

FREQUENCY	COMPONENT	TYPE OF INTERVENTION	REFERENCE
Weekly or every 50 operating hours	Blade	Clean and check blade efficiency	(See Par. 6.2)
		If the blade is bent due to impact or if it's worn, replace it	(See Par. 6.3)
	Recharging contacts	Clean and eliminate any oxidising.	(See Par. 6.2)
Monthly or every 100 operating hours	Robot lawn mower	Clean	(See Par. 6.2)
	Charging base and power cables	Check for wear or deterioration and replace if necessary	(Contact an authorised service centre)
At the end of the mowing season or every six months if the robot lawn mower is not used	Battery	Perform the pre-storage charging of the battery	(See Par. 6.4)
Annual or at the end of the cutting season	Robot lawn mower	Carry out the servicing at an authorized service centre	(See Par. 6.1)

It is necessary to carry out a maintenance servicing annually at an authorized service centre to keep the robot lawn mower in good working conditions.

The servicing provides for a series of verifications including:

- the internal and external cleaning of the robot lawn mower;
- the general check of the status of the robot lawn mower;
- the replacement of worn parts;
- the checking of the battery status;
- the verification of tightening torques;
- the verification and possible replacement of the impact and lifting kinematic mechanisms and their protective bellows;
- the check and, if necessary, replacement of the rubber bellows protecting the blade motor, to maintain the protection specifications against water infiltrations
- the replacement of the sealing gaskets of the bodies and the battery compartment to maintain the specifications of protection against water infiltrations.

NOTE: any malfunction due to not having carried out the annual servicing will not be recognized under warranty.

6.2. PRODUCT CLEANING

	CAUTION: Danger of cutting hands.		CAUTION: Danger of dust in the eyes.
---	---	---	--

Requirements and obligations:

- | | |
|--|--|
| <ul style="list-style-type: none"> • Sponge • Neutral soap • Brush • Water | <ul style="list-style-type: none"> • Dry cloth • Gloves • Glasses |
|--|--|

	GLOVES OBLIGATION: Use protective gloves to avoid cutting your hands.		GLASSES OBLIGATION: Use safety glasses to avoid the danger of dust in the eyes.
---	---	---	---

Procedure:

1. Press the “**STOP**” (A) button to stop the robot lawn mower and open the protective cover (B).
2. Switch off the robot lawn mower in safety conditions (see par. 2.3).
3. Remove the floating cover (D) to make the cleaning easier.
4. Clean all the external surfaces of the robot lawn mower with a sponge dampened in lukewarm water and neutral soap.

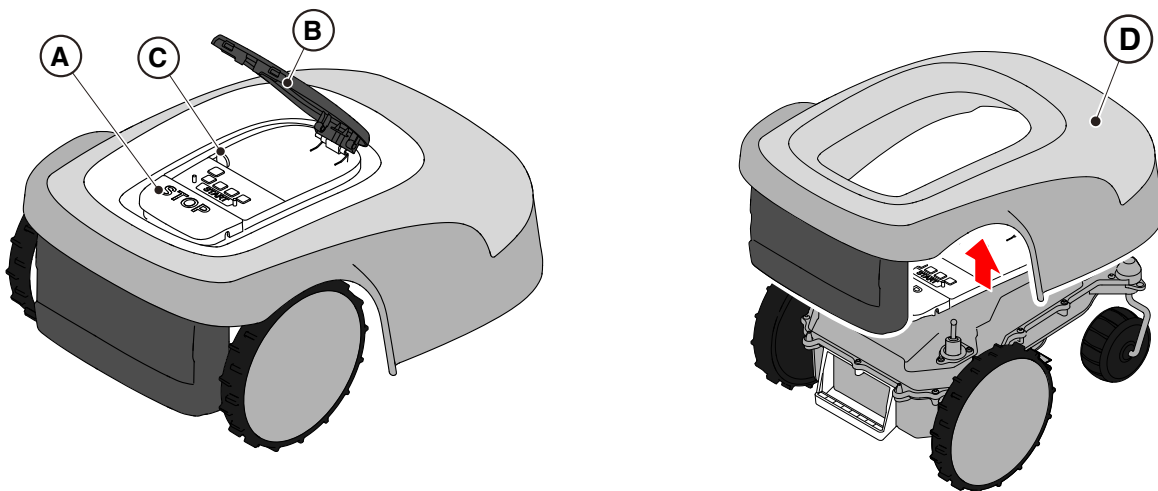

WARNING:
 Too much water can filter in and damage electrical parts.



WARNING:
 Do not modify, tamper with, elude or eliminate the safety devices installed.



BAN:
 Do not use pressurized water jets.



BAN:

To avoid irreversible damage to the electrical and electronic components, do not immerse the robot lawn mower, partially or completely, in water.



BAN:

Do not wash the internal parts of the robot lawn mower to avoid damaging the electrical and electronic components.



BAN:

Do not use solvents or petrol so as not to damage varnished surfaces and plastic parts.

5. Remove mud and dirt from the drive wheels (F).
6. Clean the underside (E) of the robot lawn mower (cutting blade area, front and rear wheels). Use a suitable brush to remove encrustations and / or debris that could prevent the robot lawn mower from working properly. Complete the cleaning with a damp sponge.
7. Check that the rubber bellows are correctly fitted, then refit the floating cover (D), making sure that it is correctly fit in the supports.
8. Clean the battery charging connector (G).
9. Clean the charging base (H) and the contact connector (I) from accumulated residues.

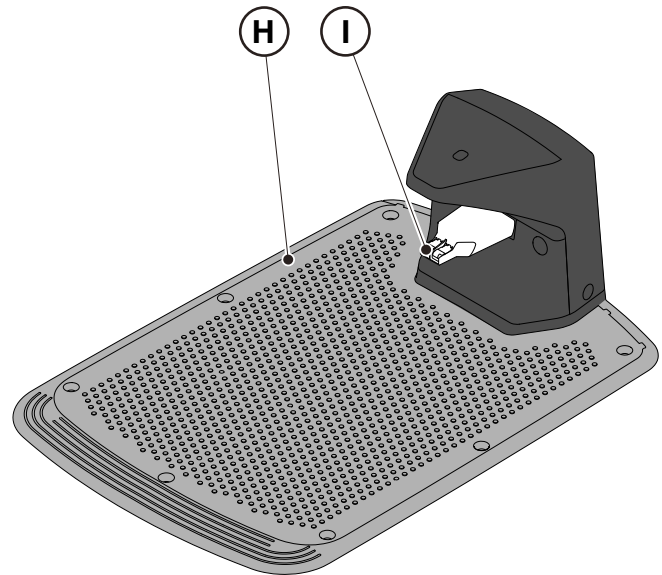
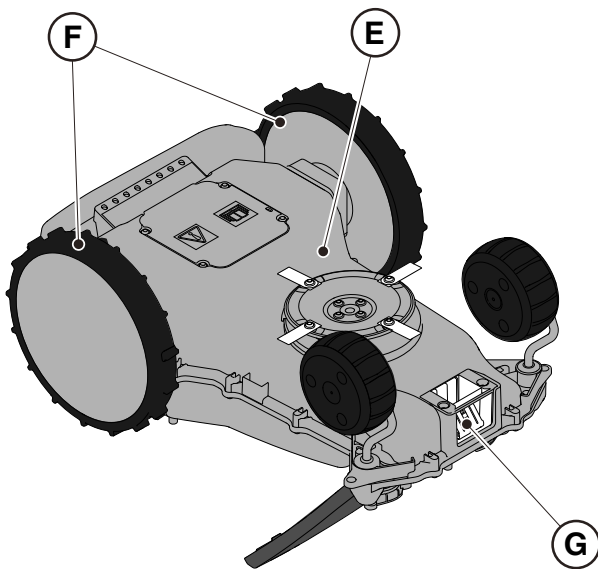

6.3. REPLACEMENT OF THE CUTTING BLADES



CAUTION:
Danger of cutting hands.

Requirements and obligations:

- Safety key
- Cutting blades
- Key
- Gloves



GLOVES OBLIGATION:
Use protective gloves to avoid cutting your hands.

Procedure:

1. Press the “STOP” (A) button to stop the robot lawn mower and open the protective cover (B).
2. Switch off the robot lawn mower in safety conditions (see par. 2.3).

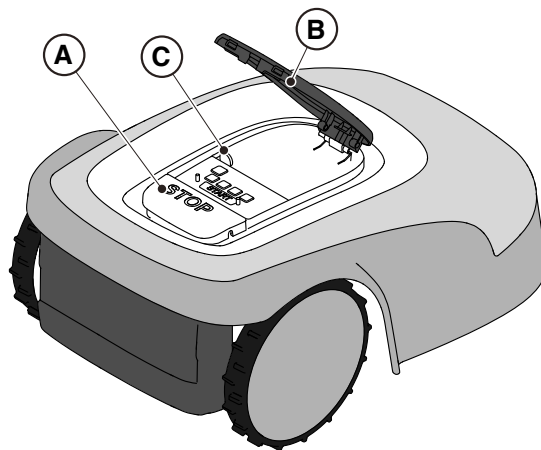

3. Turn the robot lawn mower upside down, taking care in not to damage the floating cover.
4. Unscrew the fixing screws (E).
5. Replace the cutting blades (D).
6. Unscrew the fixing screws (E).

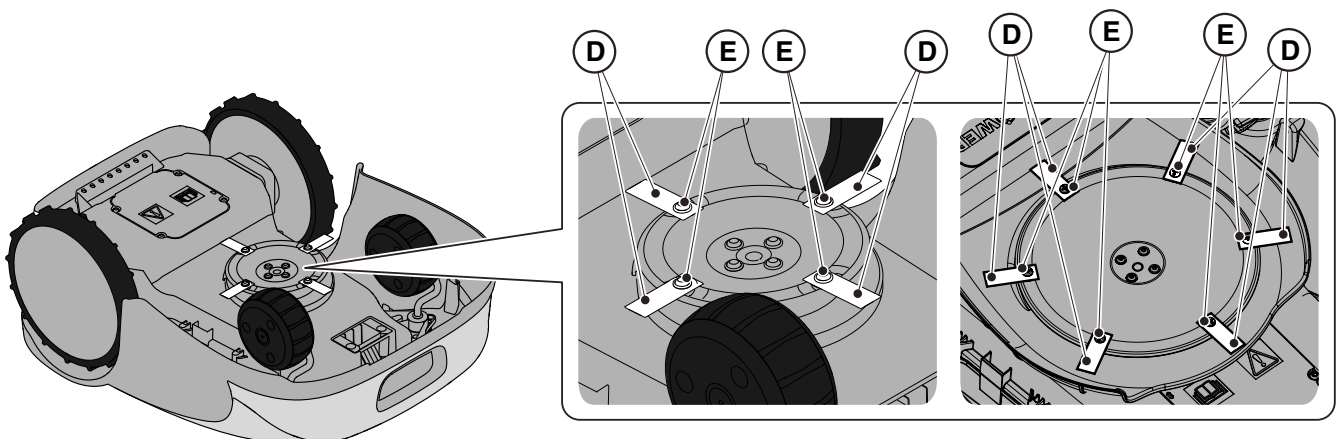

A300, A500, A750,
A1000, A1500
(TYPE SRSA01)

A3000, A5000,
A7500, A10000
(TYPE SRBA01)

6.4. WINTER BATTERY MAINTENANCE AND STORAGE

Procedure:

1. Charge the battery according to the guided procedure in the App, accessible from the "Settings" page.
2. Clean the robot lawn mower (See Par. 6.2).
3. Store the robot lawn mower horizontally, in a dry place and protected from frost, making sure it is switched off.
4. Disconnect the charging base and the satellite reference station from the mains.

NOTE: The guided procedure registers the successful recharging of the battery in the cloud, and is to be considered completed if the date of the winter pre-storage recharge is updated.

NOTE: Registering the charge through the app procedure is required for the battery warranty to be valid.

NOTE: The battery must be recharged every 6 months and, in any case, before winter storage.

NOTE: If you wish to remove the charging base and/or satellite reference station from the installation site during the winter, you must ensure that their position remains exactly the same when reassembled. If the satellite reference station is moved, the virtual boundaries, transition routes and areas to be avoided must be reconfigured through the APP.

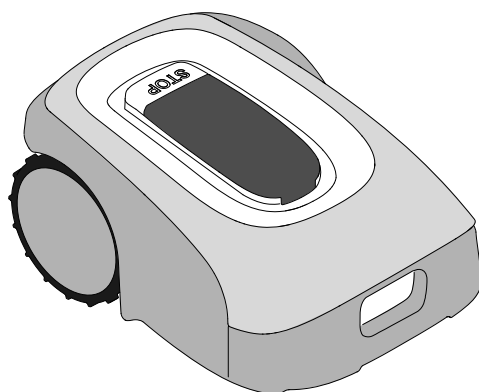

6.5. BATTERY REPLACEMENT

Battery replacement is the sole responsibility of the STIGA TECHNICAL ASSISTANCE STAFF. If the battery needs to be replaced, contact a service centre or your retailer.

7. TROUBLESHOOTING



CAUTION:

Stop the robot lawn mower and bring it back to safety conditions (See Par. 2.3).

Below there is the list of any anomalies that may arise during the work phase.

PROBLEM	CAUSES	SOLUTIONS
Abnormal vibrations. The robot lawn mower is noisy.	Damaged cutting disc or blades	Replace the damaged components (See Par. 6.3).
	Cutting device blocked by residues (tapes, ropes, plastic fragments, etc.).	Switch off the robot lawn mower in safety conditions (See Par. 2.3). Unlock the cutting blade.
	The robot lawn mower was started in the presence of unexpected obstacles (fallen branches, forgotten objects, etc.).	Switch off the robot lawn mower in safety conditions (See Par. 2.3). Remove obstacles and restart the robot lawn mower (See Par. 5.3.9).
	Electric motor failure	Replace the motor, contact the nearest authorized service centre.
	Grass too tall	Increase the cutting height (See Par. 5.6). Make a preliminary cut of the area with a normal lawn mower (See Par. 5.6).
The robot lawn mower does not position itself properly inside the charging station.	Land subsidence in the vicinity of the charging base.	Restore the correct positioning of the charging base. (See Par. 4.5.1).
	Problem with the charging base antenna.	If the problem persists, contact a service centre.
	The charging base has not been calibrated correctly, or electromagnetic interferences may be present in the vicinity of the base.	After eliminating the source of disturbance, calibrate the charging base through the app. (See Par. 4.7.6).
The robot lawn mower works at the wrong times.	Working time set incorrectly	Reset the working hours (See Par. 4.7).
The working area is not mowed completely.	Insufficient working hours.	Extending the working hours (See Par. 4.7.12).

The working area is not mowed completely.	Insufficient working hours.	Extend working hours (See Par. 4.7.12).
	Cutting device with encrustations and / or residues.	Switch off the robot lawn mower in safety conditions (See Par. 2.3). Clean the cutting device.
	Pivoting cutting blades blocked by encrustations or residues.	Switch off the robot lawn mower in safety conditions (See Par. 2.3). Replace the cutting blades.
	The working area is too large for the robot lawn mower's capacity.	Reduce the work area (see Technical Data Par. 1.2).
	Batteries about to exhaust their life cycle.	Replace the batteries with original spare parts (See Par. 6.4).
	Batteries are not charged completely.	Clean and eliminate any oxidation from the contact points (See Par. 6.2). Recharge the batteries.
The charging base light does not turn on when the robot is out of the charging base.	The supply voltage is missing or there is a fault in the charging base.	Check that the power supply unit is plugged in correctly. Check the integrity of the power supply connection cable.
The charging base indicator lights up flashing slowly.	The charging base was not set up correctly.	Set up the charging base through the app. (See Par. 4.7.5).
The charging base indicator light flashes rapidly.	There is a fault in the charging base.	Disconnect the charging base from the mains and reconnect it after a few minutes. If the problem persists, contact a service centre.
The charging base indicator lights up flashing twice or three times rapidly.	The charging base has detected a short circuit on the charging contacts.	Disconnect the charging base from the mains, rectify any short circuits and clean the charging contacts of the charging base and the robot. Reconnect the charging base to the mains. If the problem persists, contact a service centre.
The Warning icon lights up on the keypad.	It indicates anomaly / failure conditions.	See the app for more information or contact a service centre.
The robot lawn mower stops temporarily in the work area.	Weak GPS signal.	If the problem persists, please contact an authorised dealer.

8. TRANSPORT, STORAGE AND DISPOSAL

8.1. TRANSPORT

Procedure:

NOTE: We recommend using the original packaging for transport over long distances.

1. Press the “STOP” (A) button to stop the robot lawn mower and open the protective cover (B).
2. Switch off the robot lawn mower in safety conditions (see par. 2.3).
3. Clean robot lawn mower as shown in Par. 6.2 "PRODUCT CLEANING".
4. Lift the robot lawn mower by the handle (D) and carry it, taking care to keep the cutting blade away from the body.
5. Reposition the robot lawn mower in its original packaging.

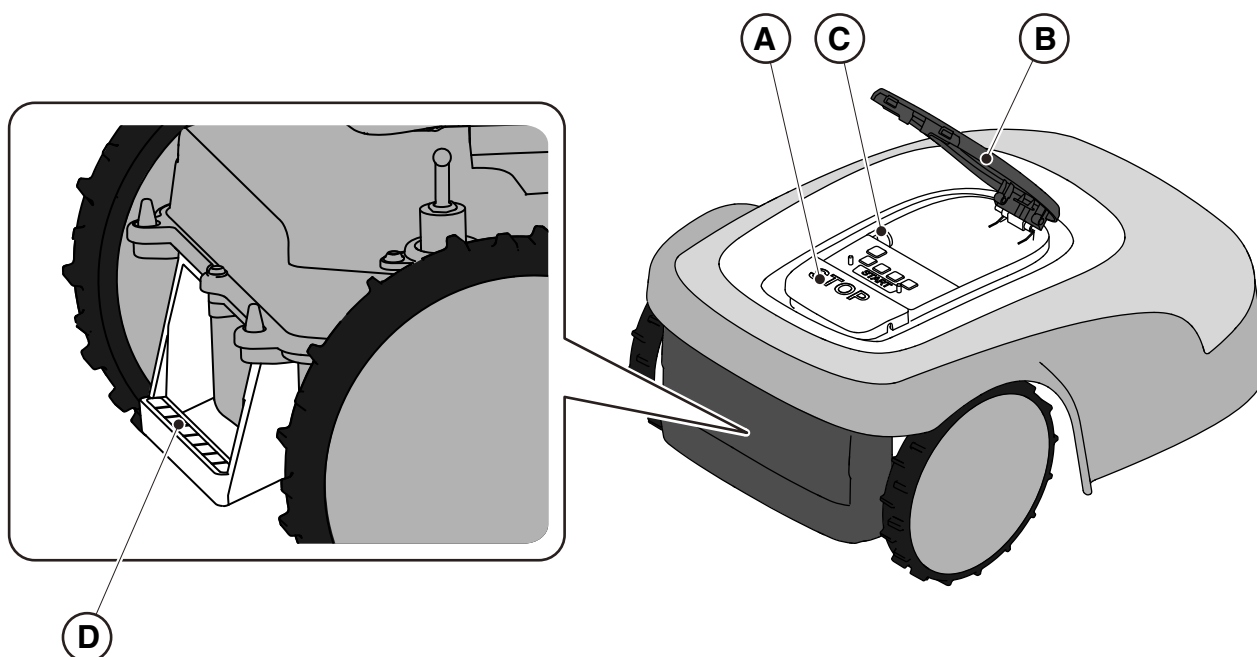

8.2. STORAGE

The robot lawn mower must be stored horizontally in a dry and frost-free place after cleaning and charging the battery in the winter (see Chap. 6). During long periods of inactivity, disconnect the charging base and the satellite reference station from the mains.

8.3. DISPOSAL



WARNING:

To remove the battery from the robot lawn mower, contact an authorized service centre.

Procedure:

1. Dispose of the product packaging in a sustainable way in the appropriate collection containers or at special centres authorized for collection.
2. Dispose of the robot lawn mower in accordance with local legal requirements.
3. Contact appropriate facilities for recycling and disposal as the robot lawn mower is classified as WEEE (Waste Electrical and Electronic Equipment).
4. Dispose of old or used batteries in a sustainable way in collection containers or at authorized collection centres.

9. ACCESSORIES

Art. number	Description	Specifications
1127-0009-01	Cutting blades	12 pcs
1127-0011-01	Charging base cover - for platform TYPE: SRSA01	For additional protection against rain and sunlight
1127-0010-01	Cable extension for charger	Cable to extend the connection between the power supply and the charging base Also usable for the satellite reference station. - L= 5 m
1127-0024-01	Charging base cover - for platform TYPE: SRBA01	For additional protection against rain and sunlight.
1127-0020-01	Cable extension for charger	Cable to extend the connection between the power supply and the charging base Also usable for the satellite reference station - L= 15 m
1127-0008-01	charging base fixing pegs	8 pcs
1127-0023-01	High-grip wheel kit - for platform TYPE: SRSA01	For more traction on slippery or uneven ground.
1127-0021-01	Trolley (Robot installation KIT)	To reduce installation time in the case of large gardens.
1127-0026-01	Blade friction disk kit - For platform TYPE: SRBA01	Reduces the friction the grass exerts on the cutting disc, improving efficiency

10. WARRANTY

10.1. WARRANTY COVERAGE

The warranty conditions are intended for consumers only, i.e. non-professional operators.

The warranty covers all material quality and manufacturing defects recognised during the warranty period by your Dealer or Authorised Service Centre.

The warranty is restricted to the repair or replacement of components recognised as faulty.

It is advisable to send your machine once a year to an authorized service workshop for servicing, assistance and safety device inspection.

The warranty only applies to machines subjected to regular maintenance.

The warranty does not cover damages resulting from:

- Failure to become familiar with the documentation accompanying the machine (Instruction manuals).
- Professional use.
- Carelessness, negligence.
- External causes (lightning, impact, presence of foreign bodies inside the machine) or incidents.
- Incorrect use or assembly prohibited by the manufacturer
- Poor maintenance.
- Modification to the machine.
- Use of non-genuine spare parts (adaptable parts).
- Use of accessories not supplied or approved by the manufacturer (e.g. cutting devices).

The warranty does not cover:

- Maintenance operations (described in the instruction manual).
- Normal wear of consumables such as cutting devices and wheels.
- Normal wear and tear.
- Deterioration in the appearance of the machine due to use.
- Cutting means supports.
- Damage resulting from an installation that does not comply with the user manual.
- Damage resulting from incorrect programming of virtual boundaries, transfer routes and areas to be avoided.
- Damage caused by water infiltration due to the use of a high pressure washing device or by immersion in water, for example when puddles of water form from heavy rain.
- Damage caused by improper storage or improper use of the battery.
- Damage caused by using non-original batteries.
- Any additional cost possibly connected to the repair under warranty, such as moving the machine to the user's premises, bringing the machine to the Dealer, hiring equipment or contracting other companies for any garden maintenance work while the machine is out of service.

The user is protected by his or her own national legislation. The user's rights under the national laws or his or her own country are not in any way restricted by this warranty.

11. REGISTERED TRADEMARKS AND LICENCES

The name and logo Bluetooth® are registered trademarks owned by Bluetooth SIG, inc. and any use made of such marks by STIGA is under license.

12. EC DECLARATION OF CONFORMITY

UK DECLARATION OF CONFORMITY

(Supply of Machinery (Safety) Regulations 2008, S.I. 2008 No. 1597, Annex II, part A)

1. The company: ST. S.p.A. – Via del Lavoro, 6 – 31033 Castelfranco Veneto (TV) – Italy

2. Hereby declares under its own responsibility that the machine:

Robotic lawnmower

a) Homologation type:	SRSA01
c) Serial number:	22A••RMO000001 ÷ 99L••RMO999999
d) Engine:	battery-operated

3. Conforms to UK Regulations:

- S.I. 2008/1597 - Supply of Machinery (Safety) Regulations 2008
- S.I. 2016/1091 - Electromagnetic Compatibility Regulations 2016
- S.I. 2012/3032 - The Restriction of the Use of Certain Hazardous Substances in Electrical and Electronic Equipment Regulations 2012
- S.I. 2017/1206 - Radio Equipment Regulations 2017

4. Reference to harmonised standards and/or to technical standards:

EN 60335-1:2012 / AC:2014 / A11:2014 / A13:2017 /
A1:2019 / A2:2019 / A14:2019
EN 50636-2-107:2015 / A1:2018 / A2:2020 / A3:2021
ETSI EN 300 328 V2.2.2
ETSI EN 301 489-1 (V1.9.2)
ETSI EN 301 489-1 V2.2.3
ETSI EN 301 489-17 V3.2.4
ETSI EN 301 489-19 V2.1.1
ETSI EN 301 489-52 V1.1.2
ETSI EN 301 908-1 V15.1.1
ETSI EN 301 908-13 V13.1.1
ETSI EN 303 413 V1.1.1

EN 61000-3-2:2014
EN IEC 61000-3-2:2019 / A1:2021
EN 61000-3-3:2013 / A1:2019
EN 55014-1:2017 / A11:2020
EN IEC 55014-1:2021
EN 55014-2:1997 / A1:2001 / A2:2008 / AC:1997
EN IEC 55014-2:2021
EN 62233:2008
EN 62311:2008

i) Cutting width: 18 cm

n) Person authorised to compile the technical file: ST. S.p.A.
Via del Lavoro, 6
31033 Castelfranco Veneto (TV) - Italia

o) Castelfranco Veneto, 07/02/2024

CEO Stiga Group
Sean Robinson

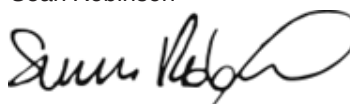

UK Importer: STIGA LTD
Unit 8, Bluewater Estate Plympton,
Devon, PL7 4JH, England



UK DECLARATION OF CONFORMITY

(Supply of Machinery (Safety) Regulations 2008, S.I. 2008 No. 1597, Annex II, part A)

1. The company: ST. S.p.A. – Via del Lavoro, 6 – 31033 Castelfranco Veneto (TV) – Italy
2. Hereby declares under its own responsibility that the machine:

Robotic lawnmower

a) Homologation type:	SRBA01
c) Serial number:	22A••RMO000001 ÷ 99L••RMO999999
d) Engine:	battery-operated

3. Conforms to UK Regulations:

- S.I. 2008/1597 - Supply of Machinery (Safety) Regulations 2008
- S.I. 2016/1091 - Electromagnetic Compatibility Regulations 2016
- S.I. 2012/3032 - The Restriction of the Use of Certain Hazardous Substances in Electrical and Electronic Equipment Regulations 2012
- S.I. 2017/1206 - Radio Equipment Regulations 2017

4. Reference to harmonised standards and/or to technical standards:

EN 60335-1:2012 / AC:2014 / A11:2014 / A13:2017 / A1:2019 / A2:2019 / A14:2019	EN 61000-3-2:2014 EN IEC 61000-3-2:2019 / A1:2021
EN 50636-2-107:2015 / A1:2018 / A2:2020 / A3:2021	EN 61000-3-3:2013 / A1:2019
ETSI EN 300 328 V2.2.2	EN 55014-1:2017 / A11:2020
ETSI EN 301 489-1 (V1.9.2)	EN IEC 55014-1:2021
ETSI EN 301 489-1 V2.2.3	EN 55014-2:1997 / A1:2001 / A2:2008 / AC:1997
ETSI EN 301 489-17 V3.2.4	EN IEC 55014-2:2021
ETSI EN 301 489-19 V2.1.1	EN 62233:2008
ETSI EN 301 489-52 V1.1.2	EN 62311:2008
ETSI EN 301 908-1 V15.1.1	
ETSI EN 301 908-13 V13.1.1	
ETSI EN 303 413 V1.1.1	

- | | |
|---|--|
| i) Cutting width: | 26 cm |
| n) Person authorised to compile the technical file: | ST. S.p.A.
Via del Lavoro, 6
31033 Castelfranco Veneto (TV) - Italia |
| o) Castelfranco Veneto, 07/02/2024 | CEO Stiga Group
Sean Robinson |

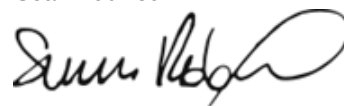

UK Importer: STIGA LTD
Unit 8, Bluewater Estate Plympton,
Devon, PL7 4JH, England



171514262/3

13. POWER SUPPLIER

OWA-60E-30STG Instruction Manual

0. Models: OWA-60E-30STG

Certificate model name: OWA-60E-30



1. Features :

- Universal AC input 100-240VAC
- Switching Power Supply
- IP67(only for power body)
- Class II power unit, no FG
- The maximum room ambient temperature is 50°C (Tmra)

Safety IEC/EN61558-1,-2-16
IEC/EN60335-1

2. Electrical rating as below:

Model	Input(ac)			Output(dc)	
	Vac	A	Hz	Vdc	A
OWA-60E-30STG	100-240	1.2	50/60	+29.2	2A

3. Block Diagram

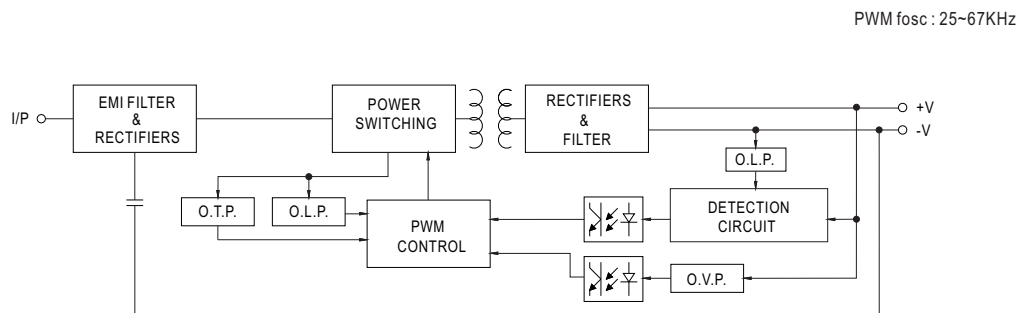

1JJ8OWA-60E-STG-RX

4. IMPORTANT SAFETY INSTRUCTIONS

- 4.1 Install only to a covered electrical socket that has an enclosure that is weatherproof with the attachment plug inserted or removed.
- 4.2 Not for use with electrical sockets that are weatherproof only when the socket is covered (attachment plug cap not inserted and electrical socket cover closed).
- 4.3 The socket-outlet shall be easily accessible.
- 4.4 When the device is installed on the wall or ceiling, it is recommended to use M3x8 screws to secure it. Fixed position as shown below:

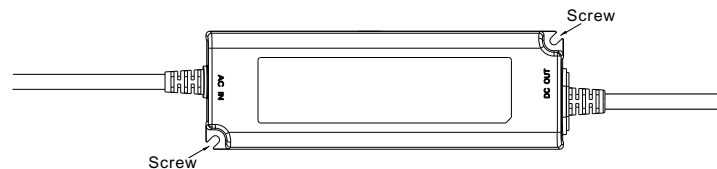

- 4.5 This appliance is not intended for use by persons (including children) with reduced physical, sensory or mental capabilities, or lack of experience and knowledge, unless they have been given supervision or instruction concerning use of the appliance by a person responsible for their safety in the end product.
- 4.6 Children should be supervised to ensure that they do not play with the appliance.
- 4.7 The supply cord cannot be replaced. If the cord is damaged the appliance should be scrapped.



4.8 :Protection of the environment. This symbol attached to the product

means that it is a device whose disposal is subject to the directive on waste from electrical and electronic equipment (WEEE). This device may not in any way be treated as household waste and must be subject to a specific type of removal for this type of waste. Recycling and recovery systems are available in your area (waste removal) and by distributors. By taking your device at its end of life to a recycling facility, you will contribute to environmental conservation and prevent any harm to your health.

4. IMPORTANT SAFETY INSTRUCTIONS

- 4.1 Install only to a covered electrical socket that has an enclosure that is weatherproof with the attachment plug cap inserted or removed.
- 4.2 Not for use with electrical sockets that are weatherproof only when the socket is covered (attachment plug cap not inserted and electrical socket cover closed).
- 4.3 The socket-outlet shall be easily accessible.
- 4.4 When the device is installed on the wall or ceiling, it is recommended to use M3x8 screws to secure it. Fixed position as shown below:

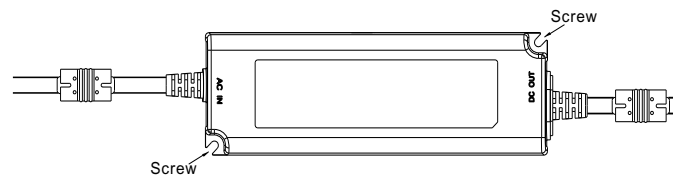

- 4.5 This appliance is not intended for use by persons (including children) with reduced physical, sensory or mental capabilities, or lack of experience and knowledge, unless they have been given supervision or instruction concerning use of the appliance by a person responsible for their safety in the end product.
- 4.6 Children should be supervised to ensure that they do not play with the appliance.
- 4.7 The supply cord cannot be replaced. If the cord is damaged the appliance should be scrapped.

4.8  :Protection of the environment. This symbol attached to the product

means that it is a device whose disposal is subject to the directive on waste from electrical and electronic equipment (WEEE). This device may not in any way be treated as household waste and must be subject to a specific type of removal for this type of waste. Recycling and recovery systems are available in your area (waste removal) and by distributors. By taking your device at its end of life to a recycling facility, you will contribute to environmental conservation and prevent any harm to your health.



STIGA LTD (UK Importer)

Unit 8, Bluewater Estate Plympton,
Devon, PL7 4JH, England

STIGA S.p.A.

Via del lavoro, 6
31033 Castelfranco Veneto (TV)
Italy

STIGA S.p.A.